



XA0054953

IAEA-TECDOC-1155

***Thorium based fuel options for
the generation of electricity:
Developments in the 1990s***

31 / 26



INTERNATIONAL ATOMIC ENERGY AGENCY

IAEA

May 2000

The IAEA does not normally maintain stocks of reports in this series. They are however collected by the International Nuclear Information System (INIS) as non-conventional literature. Should a document be out of print, a copy on microfiche or in electronic format can be purchased from the INIS Document Delivery Services:

INIS Clearinghouse
International Atomic Energy Agency
Wagramer Strasse 5
P.O. Box 100
A-1400 Vienna, Austria

Telephone: (43) 1 2600 22880 or 22866
Fax: (43) 1 2600 29882
E-mail: chouse@iaea.org

Orders should be accompanied by prepayment of 100 Austrian Schillings in the form of a cheque or credit card (VISA, Mastercard).

More information on the INIS Document Delivery Services and a list of national document delivery services where these reports can also be ordered can be found on the INIS Web site at http://www.iaea.org/inis/dd_srv.htm.

IAEA-TECDOC-1155

***Thorium based fuel options for
the generation of electricity:
Developments in the 1990s***



INTERNATIONAL ATOMIC ENERGY AGENCY

IAEA

May 2000

The originating Section of this publication in the IAEA was:

Nuclear Power Technology Development Section
International Atomic Energy Agency
Wagramer Strasse 5
P.O. Box 100
A-1400 Vienna, Austria

THORIUM BASED FUEL OPTIONS FOR THE GENERATION OF ELECTRICITY:
DEVELOPMENTS IN THE 1990s

IAEA, VIENNA, 2000

IAEA-TECDOC-1155

ISSN 1011-4289

© IAEA, 2000

Printed by the IAEA in Austria
May 2000

FOREWORD

The IAEA has maintained an interest in the thorium fuel cycle and its worldwide utilization within its framework of activities. Periodic reviews have assessed the current status of this fuel cycle, worldwide applications, economic benefits, and perceived advantages with respect to other nuclear fuel cycles.

Since 1994, the IAEA convened a number of technical meetings on the thorium fuel cycle and related issues. Between 1995 and 1997, individual contributions on the thorium fuel cycle were elicited from experts from France, Germany, India, Japan, the Russian Federation and the USA. These contributions included evaluations of the status of the thorium fuel cycle worldwide; new incentives to use thorium due to the large stockpiles of plutonium produced in nuclear reactors; new reactor concepts utilizing thorium; strategies for thorium use; and an evaluation of the toxicity of the thorium fuel cycle waste compared to that from other fuel cycles. The results of this updated evaluation are summarized in this publication as a contribution toward documenting past experience.

The IAEA would like to thank individuals who participated in the consultants meeting, and provided written contributions. Special thanks to I.A. Weisbrodt (Germany), who compiled the expert input; and to A.M. Baxter (USA) who reviewed the final draft. The IAEA staff member responsible for this publication was V. Arkhipov of the Division of Nuclear Power.

EDITORIAL NOTE

The use of particular designations of countries or territories does not imply any judgement by the publisher, the IAEA, as to the legal status of such countries or territories, of their authorities and institutions or of the delimitation of their boundaries.

The mention of names of specific companies or products (whether or not indicated as registered) does not imply any intention to infringe proprietary rights, nor should it be construed as an endorsement or recommendation on the part of the IAEA.

CONTENTS

1.	INTRODUCTION	1
2.	BACKGROUND	1
3.	DETAILED CONTRIBUTED REPORTS ON THE STATUS OF THORIUM FUEL OPTION IN THE VARIOUS COUNTRIES	12
3.1.	Incentives and justification for the thorium fuel cycle	12
3.1.1.	France	12
3.1.2.	Germany	12
3.1.3.	India	13
3.1.4.	Japan	16
3.1.5.	Russian Federation	16
3.1.6.	USA	19
	References	20
3.2.	Status of thorium use in power reactors	22
3.2.1.	France	22
3.2.2.	Germany	22
3.2.3.	India	23
3.2.4.	Japan	26
3.2.5.	Russian Federation	26
3.2.6.	USA	29
	References	30
3.3.	Non-traditional power reactor concepts	32
3.3.1.	Melt-proof reactor concepts (Germany)	32
3.3.2.	Molten salt reactor (Japan)	32
3.3.3.	Aqueous suspension reactor project (Netherlands)	34
3.3.4.	Gas turbine modular helium reactor (USA)	35
	References	39
3.4.	Strategies for thorium use (pure thorium scenario; combined with Pu; comparisons)	40
3.4.1.	France	40
3.4.2.	Germany	41
3.4.3.	India	42
3.4.4.	Japan	47
3.4.5.	Russian Federation	52
3.4.6.	USA	53
	References	56
3.5.	Nuclear design including computer codes and their validation (nuclear data; nuclear code design; nuclear fuel cycle studies regarding fuel consumption; safety aspects)	58
3.5.1.	France	58
3.5.2.	Germany (in co-operation with Brazil, Switzerland, United Kingdom)	58
3.5.3.	India	61
3.5.4.	Japan	64
3.5.5.	Russian Federation	76
3.5.6.	USA	81
	References	82
3.6.	Fuel cycle technologies (Th-resources; prospecting and mining; Th-fuel fabrication; fuel performance; reprocessing)	85

3.6.1. Germany	85
3.6.2. India	89
3.6.3. Japan	92
3.6.4. Russian Federation	102
3.6.5. USA	105
References	106
3.7. Thorium use in neutron source driven systems	109
3.7.1. France	109
3.7.2. Germany	109
3.7.3. India	109
3.7.4. Japan	112
References	114
3.8. Toxicity and related problems	115
3.8.0. General: Definition of the toxicity of radioactive waste	115
3.8.1. France	116
3.8.2. Germany	119
3.8.3. India	119
3.8.4. Japan	120
3.8.5. Russian Federation	122
3.8.6. USA	127
References	127
 ABBREVIATIONS	 129
 APPENDIX I: PROPERTIES OF THORIUM	 133
 CONTRIBUTORS TO DRAFTING AND REVIEW	 137

1. INTRODUCTION

Most of the world's nuclear reactors use fuel in which uranium is enriched to less than 10 per cent ^{235}U , the only naturally occurring, thermally fissile, isotope. Neutron capture by the fertile material ^{238}U produces plutonium. However, there has long been interest in using thorium as a fertile material to produce ^{233}U , an isotope of uranium with the best neutronic properties, as a thermal reactor fuel. Thorium is far more abundant in nature than uranium.

The use of thorium based fuel cycles has been studied for about 30 years, but on a much smaller scale than uranium or uranium/plutonium cycles. Many incentives have been identified for its use including the fact that public concerns have increasingly focused on the high radiotoxicity and long lived of waste produced during reactor operation. In addition, the end of the Cold War raised concerns about the non-proliferation of nuclear power, that is, on the large stockpiles of Pu produced in civil and military reactors. These changes have further stimulated consideration of thorium based fuel cycles. Some aspects include:

- Increasing the world's fissile resources by breeding ^{233}U from thorium;
- Improving fissile fuel utilization in thermal reactors;
- Significantly reducing ^{235}U enrichment requirements;
- Decreasing production of Pu, and other transuranic elements compared to uranium fuel cycles;
- Achieving higher fuel burnups than uranium based fuel cycles;
- Realizing the potential for Pu burning (civil-grade or weapon-grade) without the need to recycle, i.e. achieving faster reduction of existing Pu stockpiles;
- Decreasing production of toxic fuel waste or long lived radiotoxic waste; and
- Developing the potential to combine the thorium based fuel cycle with accelerator driven systems and hybrid fusion driven systems, to breed ^{233}U and incinerate long lived radiotoxic isotopes.

Thorium based fuel can be used in all proven reactor types, including PWRs, WWERs, BWRs, HWRs, FBRs, HTRs/HTGRs and in possible future reactor concepts, such as the molten salt reactor or aqueous homogenous suspension reactors. Thus it may be possible to realize economic benefits through its use. However, significant financial input will be necessary to reach the same large scale industrial status already attained by the U/Pu cycle.

The consideration of possible advantages, especially for constraining plutonium production and reducing long term fission waste levels, has led to renewed international interest in the thorium based fuel cycle.

2. BACKGROUND

THORIUM FUEL CYCLE DEVELOPMENT AROUND THE WORLD

Research and development

Basic research and development on the thorium fuel cycle has been conducted in Germany, India, Japan, the Russian Federation, the United Kingdom, and the USA. Studies included the determination of material data, fabrication tests on a laboratory scale, irradiation of Th-based fuel in material test reactors with post-irradiation examinations, and

investigations into the use of Th-based fuel for LWRs (including WWERs), LMFBRs, and HTRs/HTGRs. Test reactor irradiation of thorium fuel to burnups at high specific heat loads (up to 680 W/cm) has also been conducted and several test reactors have been either partially or completely loaded with Th-based fuel. In particular experiments have been conducted in:

The AVR (Germany)

- 127 000 hours of operation, about 95 per cent with Th-based fuel at 15 MW(e), has been activated. Approximately 300 thousand fuel balls containing a total of 1360 kg of Th were used. Maximum burnups of 150 000 MW·d/t burnup were achieved.

The Dragon reactor, United Kingdom

- Thorium fuel elements with a 10/1 Th/U (HEU) ratio were irradiated in this 20 MW(th) reactor (950°C He-outlet temperature) for 741 full power days.

KUCA facility (Japan)

- Many critical experiments have been conducted here with metallic Th and enriched U.

The Peach Bottom HTGR, USA

- The Peach Bottom reactor was a high-temperature, graphite-moderated, helium-cooled reactor experiment operating at 110 MW(th) with HEU/Th coated-particle fuel.

CIRUS reactor, India

- Irradiation of Th-based test fuel rods and Th/Pu-based test fuel rods (with up to 18 000 MW·d/t burnup) has been conducted.

These experiments included post-irradiation examination of spent Th-based fuel from the reactors; and fabrication of Th-based fuel, both on a pilot and semi-industrial scale (AVR). In addition, in most of these countries, R&D has been directed at reprocessing spent Th-based fuel both on a laboratory and a pilot-scale and on laboratory re-fabrication tests.

Power reactors

Considerable experience has been gained in thorium based fuel in power reactors worldwide. The following reactors have either irradiated thorium fuel or are preparing test irradiations:

THTR (Germany)

A 300 MW(e) reactor was operated with 675 000 pebbles containing Th/HEU fuel but shut down after 3 years for non-technical reasons. Fuel fabrication was on an industrial scale.

Fort. St. Vrain (USA)

The Fort St. Vrain (FSV) reactor was the most recent thorium fueled (Th/HEU) [2.1] nuclear power plant operating in the USA. FSV was a high-temperature, graphite-moderated, helium-cooled reactor with thorium and high-enriched uranium (HEU) fuel designed to operate at 842 MW(th). The fuel was in microspheres of thorium carbide and Th/²³⁵U carbide (4/1) coated with silicon oxide and pyrolytic carbon to retain fission products. Almost 25 metric tons of thorium fuel was manufactured for the FSV reactor. Excellent agreement was obtained between reactor physics measurements and calculations for control rod worth, temperature coefficient of reactivity, and reactivity behavior with burnup.

Shippingport/PWRs (USA)

Thorium based fuel for PWRs was investigated [2.2] using both ^{235}U and plutonium as the initial fissile material and it was concluded that it would not significantly affect operating strategies or core margins. In this regard, a nuclear energy center (NEC) was proposed [2.3] to utilize reprocessed plutonium. A thorium based, plutonium-burner, LWR fuel cycle was analyzed for the NEC to burn the plutonium and convert ^{232}Th to ^{233}U . The ^{233}U would then be denatured as fissile feed for reactors outside the NEC. The light water breeder reactor (LWBR) concept was also tested in the Shippingport reactor using thorium and ^{233}U fuel in Zircaloy-4 clad. The core was operated from 1977 to 1982 and successfully demonstrated breeding of ^{233}U using the "seed/blanket" concept [2.4].

BWR, Lingen (Germany)

This 60 MW(e) reactor utilized Th/Pu-based fuel test elements.

Angra 1 (Brazil)

Tests of Th/U- and Th/Pu-based fuel test elements in the 900 MW(e) PWR have been prepared (including licensing documentation) within a program of German-Brazilian cooperation, but were not carried out [2.5].

KAPS units 1 and 2, KAIGA units 1 and 2, and RAPS 3 and 4 (India)

Each KAPS unit is loaded with 500 kg Th-fuel; in June 1995, Unit 1 had achieved about 300 days of full power operation, Unit 2 about 100. The power plants for KAIGA and RAPS are under construction, but the use of Th-based fuel is planned for power flattening. Work on post-irradiation examinations, reprocessing (laboratory scale and pilot-scale) and re-fabrication (laboratory scale) continues and has been enlarged based on these experiments.

Emerging advanced reactor concepts

Advanced reactor concepts based on thorium-fuel cycles are under study for future nuclear applications; some concepts are:

Water cooled reactors

The fuel of these reactors is based on PuO_2 -, ThO_2 - and/or UO_2 -particles arranged in ring-shaped SiC-coated pellets in steel cladding tubes (LWRs); and on SiC-coated PuO_2 -, ThO_2 - and/or UO_2 -particles, arranged in stainless steel coated graphite balls and ring-shaped cores (HWRs) [2.6, 2.7].

HTRs/HTGRs or MHRs

A near term application of such reactors has been investigated in detail in Germany. These are the modular high-temperature reactors (MHTRs) with spherical fuel elements.

Research on high-temperature gas cooled reactors (HTGRs) in the USA led to the design of a small version of this concept using a prismatic fuel element and known as the modular helium reactor (MHR). The MHR combines low power density (6 W/cm^3), with an annular core and negative temperature coefficients of reactivity under all conditions, to

provide an inherently safe system operating at high coolant temperatures. Use of helium as a coolant at high temperature, and the relatively small power output per module (600 MW(th)), permit direct coupling this reactor to a gas turbine in a Brayton cycle, resulting in generation at almost 50 per cent efficiency. The combined power generating system is known as the gas turbine modular helium reactor (GT-MHR). The GT-MHR core can accommodate a wide range of fuel options. In particular, it can use thorium based fuel cycles with the potential for the highest possible thermal reactor conversion ratios, HEU/Th, $^{233}\text{U}/\text{Th}$, and Pu/Th. The HEU/Th fuel has been demonstrated in the operation of the Fort St. Vrain reactor.

Molten salt reactors

Although this concept was studied in depth in the 1960s, it is being reinvestigated because of the availability of advanced technology for the materials and components, as well as for the expected high conversion rate (^{233}U) from thorium based fuel.

Aqueous homogenous suspension reactor

This project is based on a fluid fuel, similar to that of the Molten Salt Reactor, but in this option the fluid fuel is circulated in demineralized water. Reprocessing occurs continuously and the conversion rate to ^{233}U is very high.

Heterogeneous thorium reactor core

The seed-blanket concept was proposed for Th use in PWR of current technology [2.7]. The basic idea is to use a heterogeneous, seed/blanket fuel assembly. The Th part of the fuel assembly is separated from the U part of the assembly allowing separate fuel management schemes for the thorium (a subcritical “blanket”) and the “driving” part of the core (“seed”). The design objective of the blanket is efficient generation and fissioning of the ^{233}U isotope, while the design objective of the seed is economical supply of neutrons to the blanket. For the Pu incineration option, Pu replaces enriched U.

Thorium use in neutron source driven systems

The term “neutron source driven systems” is applied to accelerator driven systems, accelerator and molten-salt breeder combinations, fusion reactor blanket systems, and fission-fusion hybrid reactors.

Accelerator driven systems

Rubbia *et al.*, of CERN [2.10] proposed the use of thorium as the feed material in accelerator driven systems. This system would have the advantages of the thorium fuel cycle in reactor applications without needing fissile uranium. It would serve as an energy source with minimum long term waste production.

In an accelerator driven system, a beam of high-energy protons from an accelerator impinges on a target of lead, lead-bismuth or other material (e.g. Hg). High-energy neutrons are produced by the spallation reaction between the high-energy protons and the target nuclei and can be directed to a subcritical reactor containing thorium. The energy of the neutrons emanating from the spallation reaction is high enough to cause fission of the thorium nuclide itself. These neutrons can be multiplied using a material like beryllium, which has an (n, 2n) reaction. Use of an external source of neutrons to maintain the neutron chain reaction opens up the possibility of achieving very high burnup of the fuel.

Accelerator breeders have been investigated by ORNL in the USA and KFA/KFK in Germany. In this concept, protons are accelerated to an energy level of 1 GeV by the accelerator and directed onto a heavy metal target, producing a cascade of secondary particles and neutrons. The neutrons are absorbed in a surrounding thorium blanket, thus breeding ^{233}U . A beam with a 300 mA current produces about 2.8 kg ^{233}U per day.

Another possible system investigated by KFA in Juelich, Germany, uses thermal neutrons and liquid fuel. The main goal is a self-sufficient system that breeds its own fuel and produces a surplus of electrical energy. The system is operated at a multiplication factor of 0.9, and at a beam current of 25 mA ($E_p = 1.6$ GeV). This results in a net system efficiency of 30 per cent and a surplus production of fissile material (^{233}U) of about 6 percent/year related to the ^{233}U inventory in the system.

Accelerator molten salt breeders

A system consisting of a molten salt target/blanket and an accelerator with a high-energy proton beam (1 GeV, 300 mA) has been investigated in Japan. The expected fissile material doubling time is about 4 years.

Fusion reactor blanket system

A fusion reactor can be used as a source of neutrons since fusion is “neutron-rich”. It is possible to combine a fusion reactor and a subcritical fission reactor so that neutrons produced in fusion support the fission reactor. The fission reactor can supplement the energy released in the fusion reaction. Considering the need to maintain very high temperatures for a sustained fusion reaction, it has been recognized that it would be much easier to design a fusion reactor if it is not expected to be a net energy producer. Thus, a thorium-fueled reactor is well suited for a symbiosis between a net energy consuming fusion reactor, and a net neutron deficient fission reactor. The advantage of this system is that it extracts energy from a fusion plasma; uses an abundant resource, thorium and provides ^{233}U fuel with low actinide production.

Advantages of the thorium fuel cycle

- *A large increase in the world's fissile resources by breeding ^{233}U from thorium*

An abundant supply of thorium is necessary to implement thorium based fuel cycles on a scale necessary to significantly supplement uranium resources. Thorium, which is essentially 100 per cent ^{232}Th , is three times more abundant in the earth's crust than uranium, reflecting the differences in the half-lives of ^{232}Th (1.4×10^{10} years) and ^{238}U (4.5×10^9 years). With no recycle, the thorium, having no fissile component, is used strictly as a replacement for ^{238}U in-core.

Thorium occurs in association with uranium and rare earth elements in diverse rock types. It occurs as veins of thorite/urano-thorite and monazite in granites, syenites, and pegmatites. Monazite also occurs in quartz-pebble conglomerates and sandstones. Moreover thorium occurs with rare earth elements in bastnaesite and carbonatites.

There are extensive deposits in Brazil, Canada, India, and the USA (Fig. 2.1 [2.10], Table 2.1 [2.11]). Most of India's thorium reserves (nearly 300 000 tons) are in the beach sands of Kerala and Orissa. The ore is very high grade with a thorium content of about 10 per cent and since it is in beach sands, mining is easy. Similar extensive deposits are found in Brazil and Canada. The USA is believed to have thorium in major deposits in California, Colorado, Idaho, Montana, New Mexico, and Wyoming but there is no current interest in exploration or mining due to lack of demand.

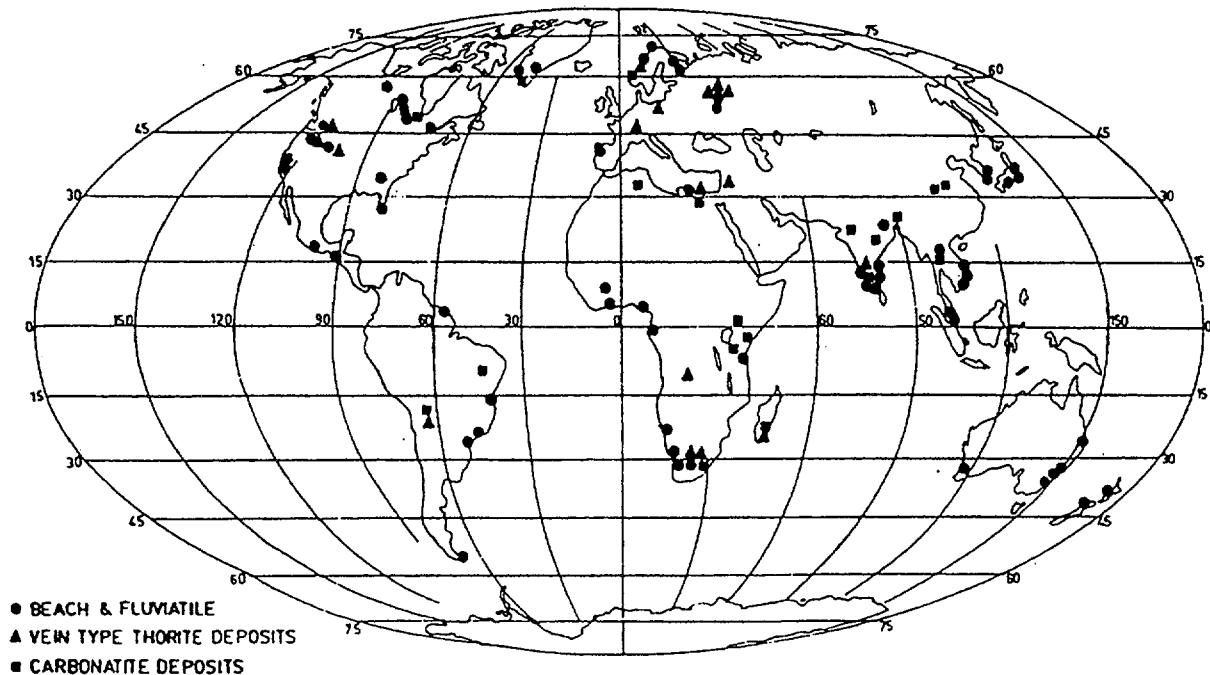

FIG. 2.1. Thorium deposits in the world.

- Improved fissile fuel utilization in thermal reactors, the potential for higher fuel burnups and hence lower fuel cycle costs, than for uranium based fuel cycles, with a significant reduction in ^{235}U enrichment requirements.

Thorium fuel cycles, which can utilize the bred ^{233}U as a fissile material, have inherent advantages over ^{235}U and plutonium fueled systems for thermal reactor applications. This advantage is shown in the Table 2.2 which compares representative η (η) values (the average number of fission neutrons produced per thermal neutron absorption), for these fissile isotopes in a typical PWR thermal reactor spectrum. As can be seen from the table, η is considerably higher for ^{233}U than any other fissile nuclide.

The high η value of ^{233}U implies that a Th/ ^{233}U fuel cycle can be designed with a high conversion ratio. A thermal breeder reactor potential for high conversion was confirmed in the USA, for HTGRs, by operation of the Peach Bottom and FSV reactors, and for PWRs, by operation of the Shippingport reactor with a thorium core. In addition, an EPRI sponsored study of thorium fuel cycles in PWRs concluded that an HEU/Th fuel cycle could increase the energy output per mined ton of uranium by 85 per cent. Further, a Pu/Th fuel cycle would be more efficient for utilizing the LWR plutonium stockpiles and could increase energy output per gram of Pu by 20 per cent.

Four different reactor types are eminently suitable for the thorium fuel cycle:

- (1) Light water breeder reactor — The seed-blanket concept of this reactor has a central core of thin Th/ ^{233}U fuel pins surrounded by a thicker core of thorium pins, all as oxide. Such a system could be fitted into an existing PWR by rearranging the core and top plate of the pressure vessel. Conversion ratios of 0.7 are feasible, compared to 0.6 values in the standard LWR.

TABLE 2.1. ESTIMATED WORLD THORIUM RESOURCES IN 1992 (MARKET ECONOMY COUNTRIES) IN 10^3 tons [2.11]

Countries	RRA	RSE	Total	%
Europe				
Greenland	54	32	86	
Norway	132	132	264	6.4
Turkey	380	500	880	21.4
Total	566	724	1290	31.4
America				
Brazil	606	700	1306	31.8
Canada	45	128	173	
United States	137	295	432	10.5
Total	790	1125	1915	46.6
Africa				
Egypt	15	280	295	7.2
Niger	?	?	29	
South Africa	18	?	115	
Total	36	309	479	11.7
Asia				
India	319		391	7.8
Total	343	30	403	9.8
World total	1754	2188	4106	100
RRA:	resources reasonably achievable			
RSE:	resources supplementary estimated			

TABLE 2.2. REPRESENTATIVE THERMAL η VALUES FOR ^{233}U , ^{235}U , ^{239}Pu , AND ^{241}Pu

	^{233}U	^{235}U	^{239}Pu	^{241}Pu
η (0.025 eV)	2.30	2.07	2.11	2.15
η (averaged over typical PWR neutron spectrum)	2.27	2.06	1.84	2.17

- (2) CANDU-type reactor — In this reactor type a self-sufficient equilibrium thorium cycle (SSET) appears possible. This cycle is initiated using Th/HEU or LEU, or Th/Pu fuel and stockpiling the ^{233}U until sufficient to start the SSET. Then the reactor acts as a converter of thorium with a conversion ratio of 1.0.
- (3) Fast breeder reactor (FBR) — A fuel cycle combining uranium metal alloyed with thorium can be used in the FBR. The thermal conductivity of the metallic alloys would allow higher specific powers than oxide fuels and together with the higher atomic density of the metals would result in an increased breeding ratio compared to the standard breeder. (This does not depend on thorium and can also be done with U/Pu).

- (4) The high temperature gas cooled reactor (HTGR) — The Th/²³³U fuel cycle is an excellent match for this reactor type. The relatively hard spectrum has little effect on the ²³³U η value since it is almost constant in this region. Conversion ratios up to 0.8 are feasible.

The molten salt breeder reactor and accelerator driven systems are also suited to the use of thorium fuel cycles, offering the prospect for high breeding gains.

- *The lower production of Pu, and other transuranic elements compared to uranium fuel cycles and the lower production of toxic fuel waste or long lived radiotoxic waste from thorium fuel cycles.*

The thorium fuel cycle has a significant lower production of long lived transuranic actinides compared to uranium-plutonium cycles. Production of higher actinides in the thorium chain is orders of magnitude lower than in the uranium chain.

- *The potential for accelerated Pu-burning (civil-grade or weapon-grade) without the need for recycle, i.e. faster reduction of the existing Pu-stockpiles.*

The thorium fuel cycle produces only ²³³U as the fissile material. Existing technology may be used to denature ²³³U by the addition of natural uranium which is always contaminated by the daughter-products of ²³²U, which are hard γ emitters. Also, the production of higher actinides is significantly reduced in the cycle, decreasing the possibility of diverting trans-plutonium actinides. In addition, Th-Pu is a fuel cycle allowing use of plutonium for energy generation and breeding of ²³³U at the same time.

Findings of the international fuel cycle evaluation study

The International Fuel Cycle Evaluation (INFCE) Study (1978–1980) [2.12] summarized Th fuel cycle activities worldwide through Working Group 8 (Advanced Fuel Cycle and Reactor Concepts). Cycle concepts, technical status, economics and technical barriers to proliferation were considered.

It was confirmed that conventional LWRs, HWRs and HTRs had been designed for operation on the U/Pu or Th/U cycles. It was stated that for all power reactor types, the technology for using Th-bearing fuels and recycle of ²³³U had been less developed than for the U/Pu cycle. In spite of significant R&D effort and demonstration projects in several countries, there were no large scale cycle facilities supporting commercial deployment of Th-based fuel. Major R&D effort was needed in the areas of neutron physics, core analysis, remote technologies for fuel fabrication, reprocessing and waste treatment.

Since Th-based fuels have not been fabricated or reprocessed commercially, there was uncertainty about costs. Specific costs for reprocessing were assumed to be of the same order or higher than that of Pu/U fuel, but re-fabrication of ²³³U-bearing fuel could be heavily penalized (factor of 1.5–9) by requiring remote operation. Estimates indicated that over a range of cost parameters Th cycles might be competitive with U/Pu cycles, once they went commercial. However, the difference did not appear large enough either to urge or discourage implementation, other factors were likely to decide the issue. These included availability of national resources, technology, industrial capabilities and national priorities and licensing environments, all varying with time and location. Analysis of technical characteristics that would inhibit proliferation for Th fuel cycles with up to 20 per cent of fissile material showed that they were similar to U/Pu cycles.

Conclusion of IAEA symposium on nuclear fuel cycle and reactor strategies: Adjusting to new realities [2.13]

The main reasons for introducing thorium based fuel cycles in the past [2.14] have been (a) the enhancement of fuel resources by breeding ^{233}U , (b) the existence of domestic thorium in some countries and conversely, shortages of uranium, (c) reduction in ^{235}U requirements, (d) good in-core neutronic and physical behaviour of thorium fuel, and (e) lower excess reactivity requirements (higher thermal conversion ratio) of Th-based cores. Set against these advantages, the principal reason that thorium has not been used more widely to date is that the ore contains no fissile isotope, as does uranium ore.

Tests to date and the experience gained on thorium based fuel in both test reactors and power reactors are very encouraging. The most noteworthy from worldwide investigations of thorium based fuels is that they can be used in all proven reactor types (HWR, LWR, FBR, HTR) without changes in reactor design, plant design or safety. Other reactor concepts such as molten salt also can utilize this fuel. In the case of HTRs, some adaptations must be made regarding the passive decay heat removal.

New realities necessitate further review of thorium based fuels and their potential role in reducing plutonium stockpiles. In addition, the high conversion ratio of thorium fuel in thermal reactors offers added flexibility in fuel cycles during the startup and introduction phase of the FBR. This flexibility arises from the reduced need for fissile fuel addition to maintain operation in existing thermal reactors, as the conversion ratio increases.

Present knowledge of the extent of thorium resources in the world is limited, even though extensive deposits of high-grade ore have been found in several countries. Extraction of thorium from ores is somewhat difficult and the economics of the large scale process are not well known. Major difficulties in separating ^{233}U from spent fuel, and the high gamma activity of the product, suggest that the most likely application is in a once-through cycle. Further, burnup (energy yield) can best be maximized by taking advantage of the high thermal conversion ratio in a well-thermalized reactor spectrum.

Drawbacks of the thorium fuel cycle

- There is no fissile isotope in thorium. Thorium has good fertile material properties.
- ^{233}U can be used as weapon material with amounts similar to plutonium or ^{235}U .
- Contamination with ^{232}U considerably complicates fuel fabrication, which must be conducted remotely behind shielding (to comply with radiological protection standards), contributing to a high fuel fabrication price.
- Significant financial outlay is necessary to reach the large scale industrial status already achieved with the U/Pu-cycle.
- The thorium fuel cycle has further need for development in:
 - (a) Validation of related data such as nuclear and material data for thorium based fuels;
 - (b) Evaluation of the impact of the toxicities of ^{231}Pa , ^{232}U , ^{233}U and ^{234}U ;
 - (c) Investigation of reactor kinetics and safety analysis resulting from the smaller effective delayed neutron fraction, β_{eff} , for ^{233}U (0.00266), than for ^{235}U (0.0065); (although it is slightly higher than for Pu [0.00212]);
 - (d) Only pilot-scale reprocessing and re-fabrication experience is available; separation of ^{233}U from spent fuel has proved quite difficult.

CONCLUSIONS

- (a) From surveying the status of development of the thorium fuel cycle in various countries, it can be concluded that the feasibility of different types of reactors based on $^{233}\text{U}/\text{Th}$ has been successfully demonstrated and the fuel cycle technologies (mining, fuel fabrication, reprocessing, and re-fabrication), are in principle, available.
 - (b) The neutronic properties of ^{233}U permit its efficient use in all types of nuclear reactors and could save natural uranium resources. This was the main reason for past thorium research.
 - (c) The chief reason for revival of interest is that studies, test reactor experiments, and power reactor experiments have demonstrated that thorium based fuel, whether in combination with U, Pu or both, has attractive features including:
 - (a) low production of Pu, and minor actinides;
 - (b) breeding of fissile material (^{233}U);
 - (c) burning of Pu; and
 - (d) transmutation of minor actinides.
- In spite of large amounts of accumulated data, better neutronic data are needed for calculations.
 - The present knowledge of the thorium reserves is poor due to the relatively small effort expended so far.
 - The advantages, problems and possible options of thorium fuel must be realistically assessed under current conditions.

REFERENCES

- [2.1] BAXTER, A. M., et al., "FSV Experience in Support of the GT-MHR Reactor Physics, Fuel Performance and Graphite", General Atomics report GA-A21925 (1994).
- [2.2] MATZIE, R. A., REC, J. R., "Assessment of Thorium Fuel Cycles in Pressurized Water Reactors", CE Power Systems TIS-5114 (1976).
- [2.3] MATZIE, R. A., REC, J. R., TERNEY, A. N., "An evaluation of denatured thorium fuel cycles in pressurized water reactors", CE Power Systems TIS-5116, (1977).
- [2.4] BEAVER, W., "Nuclear Power Goes On-Line, A History of Shippingport", Greenwood Press (1990).
- [2.5] PINHEIRO, R.B., "Brazilian experience on thorium fuel cycle investigations," paper presented at IAEA Advisory Group Meeting on Thorium Fuel Cycle Perspectives, Vienna, (1997).
- [2.6] REUTER, H., LOHNERT, G.H., "The modular high-temperature reactor, Nuclear Technology", **62** (1983) 22–30.
- [2.7] TEUCHERT, E., RUETTEN, H. J.; HAAS, K.A., "Rechnerische Darstellung des HTR-Modulreaktors", Jul 2618, Julich (1992).
- [2.8] GALPERIN, A., RADKOWSKY, A., TODOSOW, M., "A competitive thorium fuel cycle for pressurized water reactors of current technology", paper presented at Advisory Group Meeting on Thorium Fuel Cycle Perspectives, Vienna, (1997).
- [2.9] INTERNATIONAL ATOMIC ENERGY AGENCY, "Accelerator-driven systems: Energy generation and transmutation of nuclear waste (status report)", IAEA-TECDOC-985, Vienna (1997).
- [2.10] JAYARAM, K.M.V., "An overview of world thorium resources, incentives for further exploration and forecast for thorium requirements in the near future", Thorium based Nuclear Fuel; Current Status and Perspectives, IAEA-TECDOC-412, Vienna (1987).

- [2.11] IAEA-TECDOC-650; "New Developments in Uranium Exploration, Resources, Production and Demand", Vienna (1992).
- [2.12] INTERNATIONAL ATOMIC ENERGY AGENCY, "International Nuclear Fuel Cycle Evaluation", IAEA, Vienna (1980).
- [2.13] Symposium on Nuclear Fuel Cycle and Reactor Strategies: Adjusting to New Realities, Key Issue Paper No. 3, IAEA, Vienna (1997).
- [2.14] JUNG, M, "Perspectives of the Thorium Fuel Cycle", JRC-ISPRA, (1996).

3. DETAILED CONTRIBUTED REPORTS ON THE STATUS OF THORIUM FUEL OPTION IN THE VARIOUS COUNTRIES

3.1. INCENTIVES AND JUSTIFICATION FOR THE THORIUM FUEL CYCLE

3.1.1. France

A thorium fuel cycle could be used in the future to supplement the uranium fuel cycle, if it could provide a significant impact on the resolution of some of the most important current and anticipated problems. The abundance of thorium fuel is important for the long term, but it probably has only a small impact over the next several decades. Currently the problems of long lived fuel waste toxicity and long lived fission products and a reduction of the Pu-stock and TRU-toxicity are becoming most urgent for nuclear power. Taking into account these concerns, the thorium fuel cycle has the potential to meet the following goals:

- (a) Prolonging exploitation of the LWR (as the most mature and lowest cost energy producers) on the basis of ^{233}U fuel,
- (b) Destruction of Pu accumulated in the stocks and TRUs from the standard LWR discharge [3.1/1],
- (c) Use of Th as the principal fuel with low waste toxicity for future NP, and
- (d) Use of Th-based fuel in accelerator driven systems (ADS) for further reduction of long term toxicity risks and to enhance safety.

3.1.2. Germany

Regarding the incentives and the justification for the use of a thorium fuel cycle one must distinguish between:

- (a) The common international interests,
- (b) Specific national incentives in some countries, and
- (c) Short and long term incentives of countries and industry (suppliers, operators).

With regard to (a), the following new incentives and justifications can be identified:

- Improved non-proliferation features of reactors and fuel cycles, and
- Burning of the Pu from reprocessed reactor assemblies fuel (in a once-through mode, if possible).

With regard to (b), India for example, has small domestic resources of uranium, while Th resources are very large.

With regard to (c),

Short term incentives

In many industrialized countries, public acceptability of the peaceful use of nuclear energy remains a critical issue. New nuclear power plants have only been started in a few countries. However, the option for the future use of nuclear energy is open in nearly all countries. For obvious reasons, the owners/operators of existing nuclear plants do not wish to endanger their existing operating license by making large modifications to the plant or core

design. Thus, the possible application of Th-based fuel must not require such changes, and must not adversely affect safety features of the overall plant.

Plant design features involved would include handling and storage facilities (at power plant site and interim/final storage), absorber rods and boron system, plant availability, fuel burnup, fuel costs, etc. Affected safety features would include radiation exposure for the operators, and the environmental impact of normal operation and accidents.

The near-term application of Th-based fuel is only attractive if convincing advantages can be demonstrated to the public and to the owners/operators:

- Lower fuel costs;
- Improved non-proliferation features (e. g. burning of inserted and/or produced Pu in a once-through mode; and
- Production of radioactive waste with distinctly lower radioactivity levels, (especially with less actinides).

Long term incentives

Irrespective of current difficulties with public acceptance of the peaceful uses of nuclear energy, the universities and research centers are obliged to continue basic research for better and safer future solutions for the design and the safety of Nuclear Power Plants. One aspect of this basic research is the potential use of Th-based fuel. So far the following incentives and needs have been identified:

- long term, lower demand for uranium if thorium is used (e. g., an increase in fissile resources; high conversion ratio of thorium to ^{233}U),
- lower nuclear fuel costs,
- use of more proliferation-resistant fuel cycles,
- burnup of Pu from reprocessed reactor fuel in a once-through mode without further reprocessing,
- application of Th-based fuel mixed with Pu in new melt-proof reactors (i.e., no Pu-release, even within the containment), and
- demonstration of the theoretical and practical possibilities of the Th-based fuel in research reactors, material test reactors and commercial nuclear power plants.

3.1.3. India

The thorium fuel cycle was originally conceived as having much higher fuel utilization than the uranium cycle, at least when restricted to thermal reactors. Fuel utilization in the first generation power reactors is of the order of 1 per cent. This can be increased to 2 or 3 per cent by repeated plutonium recycle, but even in the CANDU, with the highest conversion ratio among all technologically proven thermal reactors, the upper limit to fuel utilization appears to be no more than 4 per cent.

Two avenues suggested themselves as ways to improve fuel utilization. One was development of fast reactors for the uranium cycle, and the other, development of thorium cycles for thermal reactors. Initially, the nuclear industry pursued both options, but with the oil shock of the seventies, energy conservation caught on in a big way, leading to a leveling of power demand in the heavy consumers of energy, viz., the western world. In this situation of

no significant power growth, the known uranium resources of the world could be considered adequate for energy needs even if the fuel inefficient first generation reactors were used and without recycle of spent fuel. A natural concomitant of this was that incentives for both the fast reactor and the thorium cycle tapered off.

That was twenty years ago. It makes sense today to take stock of the present situation, and decide whether circumstances have been altered, or whether new issues have arisen justifying or providing incentives for reopening the case for thorium.

- (a) For many threshold countries, among which is India, the advantage of superior fuel utilization in the thorium cycle is relevant and an incentive to develop it. But the altered international politico-economic state also brings up a number of other incentives for the thorium cycle, and these should not be ignored.
- (b) A major advantage of the thorium fuel cycle is a significant reduction in the production of long lived transuranic actinides. The mass number of thorium is 232 compared to 238 for uranium meaning that thorium must absorb six neutrons to reach the same atomic weight as uranium. Because of this, the production of transuranic long lived actinides is orders of magnitude lower in the thorium cycle than in the uranium cycle. One of the main arguments of anti-nuclear activists is that the nuclear industry produces fission products and higher actinides that pose health problems for humans by contaminating ground water or by entering the food chain. Most of the fission products are sufficiently short lived that their activity is reduced to less than that of uranium ores in a few hundred years, during which period a safe method of storage is feasible. However, the actinides continue to be radioactive for thousands of years and, in the words of one anti-nuclear activist, "that is a period longer than any known civilization has had a continual existence". The argument may be fallacious, today's civilization, unlike Roman, Greek or Mayan cultures, is not locally confined. However, the anti-nuclear movement is not a rational but an emotional issue, and it makes sense for the nuclear industry to allay such fears even if groundless. Turning to thorium in place of uranium can do this.
- (c) Non-proliferation is another important concern today. The fear of more and more countries acquiring nuclear weapons is so great that there is a tendency to dismiss nuclear power entirely. The availability of 93 per cent enriched uranium has been curtailed, and there is tremendous insecurity about plutonium produced in commercial reactors. In such a scenario, the thorium cycle merits renewed study because they lend themselves to special design for non-proliferation. For example, if thorium is initially mixed with ^{238}U , the ^{233}U produced will be contaminated with ^{238}U , from which it cannot easily be separated. The proportions of thorium and ^{238}U can be adjusted so the final uranium does not exceed a fissile content of 12 per cent, or an acceptable value. It is not possible to develop similar solutions for the plutonium produced in the uranium cycle.

U-233 has another quality making it naturally proliferation resistant. ^{233}U produced in a reactor is always contaminated with ^{232}U . This ^{232}U undergoes an alpha decay to produce ^{228}Th , then is followed by a decay chain including ^{212}Bi and ^{208}Tl , both hard gamma emitters. The presence of these two makes ^{232}U a difficult material to handle and thereby to divert to weapons use.

- (d) Today, the world is awash in plutonium. Commercial reactors generate large quantities of civil plutonium and weapon grade plutonium is available from dismantled warheads. There is a question of what is to be done with this plutonium. If nuclear terrorism is a serious concern, then any kind of burial or disposal would be unwise,

because such stores could fall into the wrong hands. In long term storage, much plutonium activity will decay, making handling easier for anyone removing it for undesirable uses. Thorium cycles offer a simple way out of this problem. The plutonium can be converted into less dangerous ^{233}U , which can be held in a relatively benign form by mixing it with ^{238}U . This way one not only eliminates plutonium, but also does it economically, by generating energy and converting it into a reserve.

- (e) Fear of proliferation has created a situation where many countries are reluctant to pursue any course that creates concentrated fissile material; both enrichment facilities and reprocessing plants have come under criticism. If the reprocessing option is abandoned, the entire volume of discharged fuel must be declared radioactive waste. Safe disposal of this "waste" would then be an important concern. Under these conditions, there would be incentives to shrink the spent fuel inventory, and high fuel burnup will help. Thorium cycles are much more suited to high burnup than uranium cycles. The advantage of the thorium cycle derives from the reactor physics properties of ^{233}U . This nuclide has an eta value 10 per cent higher than ^{235}U or ^{239}Pu in the thermal spectrum. Due to this, the slope of the reactivity vs. burnup curve of thorium fuel is much lower than for uranium. The initial enrichment required for the same discharge burnup is significantly higher for uranium fuels than that for thorium. At the time of refueling, fresh fuel assemblies produce much more power than the surrounding burnt assemblies and this can cause power peaking problems. Such problems are much more manageable with thorium fuel due to the lower initial enrichment and consequent lower power peaking.
- (f) The higher eta value of ^{233}U also has the result that swings over the fuel lifetime of the fissile content and reactivity of thorium fuels are much smaller than in uranium cycles. Thus, over the lifetime of a core, variations in reactivity and power distribution are less than in a uranium core. This property gives a significantly greater flexibility to programs based on thorium. If politico-economic factors demand changes in the nuclear power ground rules, a thorium cycle can adjust to changing conditions much better than uranium based cycles.

For example, today it seems important to reduce all plutonium stocks, but in the future altered perceptions may dictate the importance of maximizing the energy extracted from plutonium. It is interesting to compare the uranium and thorium cycles in such a scenario. In the uranium cycle, the only way to eliminate plutonium is to burn it in an inert matrix. This process irretrievably gets rid of plutonium, and later, nothing is left for energy production. In the thorium cycle however, plutonium is converted into ^{233}U , and continues to be available for energy production.

It is pertinent to add that the above scenario is neither academic nor wishful thinking, in fact it is very probable. The energy excess today is supported by large installed capacities of nuclear power in the western world. If nuclear power is really phased out, the energy crunch will make itself felt once again. Already there have been reports of brownouts from some parts of the USA.

- (g) It is important to emphasize the ease with which thorium based fuel can be back fitted into just about any existing reactor. The advantages of better neutron economy can be realized in all modern reactors with their proven technology, whether light water, heavy water or gas cooled reactors. Breeding with the thorium cycle has been demonstrated in the Shippingport reactor in the USA, and very high burnups have been realized in the AVR of Germany.

- (h) The seven points above are pertinent but it is possible that, at the moment, industry does not find sufficient incentive to extensively employ thorium cycles. Considerable work has been conducted on thorium cycles in various parts of the world over the last 40 years. But in most places today, thorium receives little attention since nuclear power itself is struggling for survival. International organizations should create a program to collate past work on the thorium cycle, current small scale work in member-states, and provide an international forum for groups still exerting considerable effort on the thorium cycle to work together as one cohesive whole. This would coordinate work underway and offer support and encouragement to countries where small groups continue working.

3.1.4. Japan

Japan depends on imports for about 83 per cent of its energy (99.6% oil, 94.4% coal and 96.0% natural gas). Since nuclear energy can be classified as semi-domestically produced energy, it has a key role in supporting Japan's fragile energy structure [3.1/4]. Japan has practically no domestic uranium resources therefore it continues the fundamental policy of promoting nuclear energy recycling. Conforming to this policy, 49 nuclear power stations currently supply about 30 per cent of the electricity. In addition, a prototype fast reactor, MONJU, is under commission, a new enrichment plant has started operation, and a reprocessing plant is under construction. These activities do not include the thorium fuel cycle but rely exclusively on the uranium-plutonium cycle.

A large number of university professors, together with some of the research staff of Japan Atomic Energy Research Institute (JAERI), have performed research projects on the thorium fuel cycle with support from a Grant-in-Aid for Scientific Research by the Ministry of Education, Science and Culture. The incentives and justification were as follows:

- (a) Security of energy supply,
- (b) Much lower production of long lived transuranic actinide nuclides,
- (c) Burnup of plutonium in stockpile and its substitution by ^{233}U , and
- (d) Thermal breeding of ^{233}U in conventional light water reactors.

These projects ended in March 1993, but many professors, and research staff of JAERI, still conduct experimental and theoretical work on thorium and several new groups have recently joined them. The incentives for this renewed interest are:

- (a) Recycling and transmutation of long lived transuranic nuclides,
- (b) Improvement of non-proliferation power generation, and
- (c) Enhancement of ^{233}U breeding by the combination of an accelerator and a subcritical assembly.

3.1.5. Russian Federation

Analysis of the current situation in the nuclear power (NP) field, particularly regarding fuel cycles [3.1/5–3.1/24], leads to the conclusion that revision is necessary for several traditional strategies for NP development. The necessity of solutions for the following major problems in the NP area becomes obvious:

- Environmental problems, including disposal of radioactive wastes;
- Problems of safety for nuclear power plants and nuclear fuel cycles (NFC);

- Non-proliferation problems caused by excess plutonium accumulation, including weapons-quality discharge material.

In principle, fast neutron reactors are capable of burning not only excess plutonium (of nearly all possible compositions) but also other transuranic elements [3.1/6–3.1/8]. However, the fast reactors of “traditional” design breed plutonium rather than destroy it. Thus, there are suggestions to modernize fast reactor designs and fuel cycles to act as burner reactors. However, this option only destroys a valuable fissile material that can later be useful. Studies have confirmed the possibility of solving these NP development problems by the introduction of so-called mixed fuel cycles using the natural resources of uranium (^{235}U and ^{238}U), thorium, and the artificial fissile isotopes ^{239}Pu and ^{233}U in thermal and fast neutron reactors [3.1/5–3.1/7].

In this case fast reactor cores would be loaded with uranium-plutonium fuel, while thorium would be the fertile material for the blankets; thus enabling an accumulation of ^{233}U for use as fuel for light water reactors.

Two important problems could be solved simultaneously by changing to ^{233}U and thorium in thermal reactors (for instance, WWER types). First, the negative temperature coefficient is larger and the core excess reactivity is smaller. Second the content of higher transuranic and trans-plutonium isotopes are significantly lower in the spent fuel of these reactors [3.1/7]. The introduction of a uranium-plutonium-thorium mixed fuel cycle would lay the foundation for future NP free of such disadvantages as accumulation of plutonium and other transuranic elements [3.1/6].

Undoubtedly, realization of the proposed plans entails considerable effort and cost. The complete thorium fuel cycle is to be assimilated, including raw materials mining and production, manufacture of corresponding fuel elements, reprocessing of spent fuel with extraction of ^{233}U and manufacture of the new fuel. The proposed mixed fuel cycle represents a flexible system, capable first, of optimizing the plutonium balance, second, of creating a new generation of light water reactors with a qualitative improvement in safety, and third, of utilizing fast reactors for burning excess plutonium and other actinides and producing ^{233}U .

The specific features of this fuel cycle are as follows [3.1/8]:

- The specific neutronic and physical parameters of thorium-uranium fuel cycle components open the possibility of an improvement in light water reactor reliability and safety and technical and economical characteristics. Compared to the other fissile isotopes, ^{233}U has the highest yield of neutrons per fission. This allows an increased breeding ratio (BR) of the thermal reactors with ^{233}U of 20–30 per cent; and of minimizing reactivity swing during reactor operation.
- A significantly weaker power and temperature dependence of the ^{233}U nuclear parameters is favorable for reactor safety, especially when changing the LWR from “cold” to “hot” conditions. In addition, it improves the advantages of using “tight” grids, including the possibility of avoiding the reactor xenon poisoning effect.
- The yield of fission products affecting reactor poisoning during operation (such as Xe, Sm, etc.) is significantly lower for ^{233}U , compared to that for ^{235}U and plutonium. This results in decreasing average cross section values of neutron absorption by ^{233}U fission products (by 25–30 per cent) and hence, lowering reactivity loss and increasing the lifetime of the core.

- The melting point of metallic thorium is 1700°C, the temperature of the first phase transition is 1400°C, and the thorium oxide melting temperature is 3200°C.
- The radiation resistance of metallic thorium is significantly higher than uranium fuel and close to that of ceramic fuel; 10–15 per cent FIMA burnup values have been confirmed by experiment.
- Metallic thorium interaction with water and steam is less intense than metallic uranium.
- Technologies have already been developed for the production of new fuel compositions of the cermet type using thorium (UO₂-Th, PuO₂-Th, etc.).

The disadvantages of thorium fueled reactors are the reactivity poisoning effects of protactinium, and the accumulation of the high γ activity isotope, ²³²U. However, the latter problem is not decisive in any case, since the change to nuclear fuel recycling inevitably requires the development of remotely controlled processes for fuel fabrication and handling.

The arrangement of natural thorium into the blankets and cores of LMFR type reactors, including modular reactors but especially in the heterogeneous arrangement results in significant improvement in safety characteristics. It favors the achievement of a negative value of the sodium void reactivity coefficient (SVRC) [3.1/8; 3.1/15; 3.1/25]. By using ²³³U in the core, an additional reduction of the SVRC positive coefficient is possible.

This is caused by the weaker power dependence of ²³³U nuclear parameters and by a significantly lower (5 to 6 times) contribution of the thorium fission, owing to its low neutron absorption cross section and high fission threshold energy. Since the average absorption cross section for thorium within the fast reactor neutron spectrum is higher than that for uranium, a sufficiently high ²³³U productivity is provided in the small-size blankets.

An essential feature of fast reactors, caused by the possibility of providing an optimal thorium core neutron spectrum for ²³³U production, is the capability of producing nearly pure ²³³U, with a ²³²U content of only 10⁻⁶-10⁻⁷ [3.1/7; 3.1/8]. This effect has been substantiated by calculations at IPPE and confirmed by experimentally irradiating thorium samples in the BN-350 reactor. The possibility of isotope-pure ²³³U production at this initial stage of the thorium fuel cycle is important, since it allows basic experiments toward realization of this fuel cycle. In addition, it simplifies ²³³U and thorium fuel manufacture for light water reactors (at least for the first stage of fuel utilization, i.e., without multiple recycling).

Fast reactors of the BN type (BN-350 and BN-600) can produce up to 100 kg/a of isotope-pure ²³³U (having a ²³²U content of about 1x10⁻⁶). Specialized heterogeneous reactors (BN-800) designed for plutonium and thorium fuel cycles can burn up to 600 kg/a of plutonium in a mixture with other transuranic elements, and to accumulate up to 700 kg of ²³³U per year [3.1/5; 3.1/10; 3.1/14].

It should be emphasized, that the concept of a mixed uranium-plutonium fuel cycles, and reactor facilities developed on its basis, does not contradict the achievements and experiences gained so far in nuclear power development. On the contrary, the proposed concept expands development prospects for traditional reactor types produced by the nuclear industry (primarily light water and fast reactors).

An important problem, whose solution determines to a considerable extent the successful realization of a thorium fuel cycle, is the radiochemical reprocessing of the irradiated fuel. It should be underscored that there are two process chains for the irradiated thorium material reprocessing. None of these chains can be combined with uranium-

plutonium fuel reprocessing under operation due to the risk of mutual pollution during reprocessing of wastes, defective products, emergency spillage, etc.

The first chain is extraction of low activity ^{233}U from the irradiated thorium blankets of LMFRs, and the recycling of low activity thorium. The second chain is the reprocessing of highly radioactive irradiated thorium-plutonium fuel.

The combination of these technologies should be studied carefully; although the basic approaches are already sufficiently clear. In particular it is necessary to account for a partial accumulation of TPEs, and their daughter radionuclides, including neptunium, when irradiating thorium-plutonium compositions. Also, the time required for fuel cooling has not yet been determined, and nor have the accumulated amounts of tritium and ^{129}I , the spectrum of radionuclides, and other basic parameters for the radiochemical plant.

Fuel composition choices for all types of reactors are very important. While metallic thorium is quite acceptable for the fast reactor blankets for the LMFR, the fuel composition problem must still be solved for WWER reactor cores. As a matter of fact, according to the reprocessing conditions of traditional oxide fuel compounds containing thorium, the dissolution of these compounds is required in a nitrogen-acid media with the addition of hydrofluoric acid in such a concentration as to corrode the equipment (special chromium-nickel alloys). Besides, when using the oxide fuel, the capacity of the dissolution unit limits the whole process. From this, metal-ceramic compounds are of great interest, especially in a Pu O₂-Th type fuel utilization.

The solution of this problem depends entirely on the compatibility of different types of thorium compositions and structural materials. This group of problems includes process and equipment development for remotely controlled manufacture of fuel compositions, fuel elements and subassemblies and product quality control. The trend is toward unification of technical approaches for remote manufacturing systems of uranium-plutonium as well as thorium-uranium and thorium-plutonium fuel, and of fuel subassemblies made on that basis while taking into account thorium recycling.

In conclusion, it should be emphasized that a change to a thorium fuel cycle significantly simplifies the solution of the problem of localization and disposal of radioactive wastes, since it is not necessary to fractionate TPEs, known for their limited solubility in the glass mass. The objects of vitrification will mainly be fractions of ^{134}Cs , ^{137}Cs and ^{90}Sr , while the great bulk of radioactive wastes can be solidified with simpler methods. At the same time, a closed thorium fuel cycle results in an accumulation of ^{232}U with the concomitant problem of eliminating its enriched fractions. On the other hand, ^{233}U in the fuel is necessary for reliable monitoring of secondary fuel storage and utilization. However, this problem is not of decisive importance, since the change to nuclear fuel recycling already requires remotely controlled processes of fuel manufacturing and handling.

3.1.6. USA

Currently no work is underway in the United States on the thorium fuel cycle nor are there plans to utilize it in the future. A hiatus on nuclear construction coupled with the low cost of uranium and lack of government support for research, make it unlikely that thorium fuel cycle work will be performed in the next several years.

In the longer term, resource utilization and fuel cycle cost concerns must lead to renewed interest in this fuel cycle. In addition, an increasing awareness of actinide waste disposal problems, and growing concerns about the proliferation potential of LWR plutonium discharge, may eventually lead to re-opening work in this area.

Thorium fuel cycles utilizing bred ^{233}U as a fissile material have inherent advantages over ^{235}U and plutonium fissile systems for thermal reactor applications. This advantage is shown in the table below comparing representative eta (η) values for the various fissile isotopes in a typical PWR thermal reactor spectrum. As can be seen from the table, η , the average number of fission neutrons produced per thermal neutron absorption, is considerably higher for ^{233}U than for any other fissile nuclide.

Representative thermal η values for	^{233}U , ^{235}U , ^{239}Pu , and ^{241}Pu			
	^{233}U	^{235}U	^{239}Pu	^{241}Pu
η (0.025 eV)	2.30	2.07	2.11	2.15
η (typical PWR spectrum)	2.27	2.06	1.84	2.17

The high η value in ^{233}U implies that a Th/ ^{233}U fuel cycle can be designed with a high conversion ratio and possibility of a thermal breeder reactor. This potential has been confirmed in the USA, for HTGRs, by the operation of the Peach Bottom and FSV reactors and for PWRs by operation of the Shippingport reactor with a thorium core. In addition, an EPRI sponsored study of thorium fuel cycles in PWRs concluded that an HEU/Th fuel cycle could increase the energy output per mined ton of uranium by 85 per cent. Further, a Pu/Th fuel cycle would be more efficient in utilizing LWR plutonium stockpiles and could increase energy output per gram of Pu by 20 per cent.

REFERENCES

- [3.1/1] SALVATORES, M., SLESSAREV, I., UEMATSU, M., "Global Approach to Transmutation of Radioactive Nuclei", NSE, 116 (1994) p.1-18.
- [3.1/2] INTERNATIONAL ATOMIC ENERGY AGENCY, "A Fresh Look at the Thorium Cycle", Expert Report, IAEA-13.30/1992.
- [3.1/3] HAMILTON, C.J., ALBERSTEIN, D., BAXTER, A.M., "Maximum Plutonium Destruction Without Recycle", General Atomics report GA-21357 (1993).
- [3.1/4] ATOMIC ENERGY COMMISSION, JAPAN, "Long term Program for Research, Development and Utilization of Nuclear Energy"; (1994).
- [3.1/5] KAZANTSEV, G.N., MUROGOV, V.M., TROYANOV, M.F., et al., "Nuclear Fuel Cycle on the Base of Th and ^{233}U ", IPPE preprint No 2183 (1991).
- [3.1/6] KOCH, L., "Transuranic element cycle in LWR-FR symbiosis", Proc. Fifth Intern. Conf. Emerging Nuclear Energy Systems: ICE-NES'89, Karlsruhe, World Scientific, Singapore (1989) 65.
- [3.1/7] TROYANOV, M.F., MUROGOV, V.M., RASKACH, F.P., CHERNOV, L.A., et al., "Alternative nuclear fuel cycle for environmentally safe nuclear power", Proc. CMEA Member States, CzSFR, Rzhzh (1990).
- [3.1/8] MUROGOV, V.M., TROYANOV, M.F., SHMELEV, A.N., "Thorium Use in Nuclear Reactors", Moscow, Energoatomizdat (1983).
- [3.1/9] TELLER, E., "Underground nuclear reactors", Prepared for 19th Session International Seminars on Planetary Emergencies, NATO Workshop on Disarmament Technologies, Erice, Sicily, Italy (1994).

- [3.1/10] INTERNATIONAL COMMISSION ON RADIOLOGICAL PROTECTION, Pergamon Press, "The Metabolism of Plutonium and Related Elements", ICRP, Publication No. 48 Oxford (1986).
- [3.1/11] TROYANOV, M.F., MUROGOV, V.M., "Safe and Environmentally Acceptable Nuclear Fuel Cycle", Power Engineering Construction (1991).
- [3.1/12] NIKAMNIN, A.R., SIROTKIN, V.YA., "Potential Ways of Fuel Cycle Improvement in USSR", Report IAEA No.38/1-81-88 (1988).
- [3.1/13] VANDEN, B.E., "Uranium and plutonium recycle", Framatome Conference and Exhibition Eurexpo. Lyon, France, Vol.1 (1990) p. 387-398.
- [3.1/14] KOCHETKOV, L.A., MATVEYEV, V.I., MUROGOV, V.M., TROYANOV, M.F., "Advanced BN-type fast reactor concept under new condition of nuclear power engineering development", Proc. Enc'90, ENS/ANS-Framatome Conf. and Exhibition Eurexpo. Lyon, France, Vol 2 (1990) p.802-806.
- [3.1/15] FREEMAN, L.B., BEANDOIN, B.R., FREDERICKSON, R.A., et al., "Physics experiments and lifetime performance of the light water", Nucl. Sci. Eng., **102** (1989) 341
- [3.1/16] INTERNATIONAL ATOMIC ENERGY AGENCY, "International Evaluation of Nuclear Fuel Cycles (INFCE), Prospects of Fuel Cycle and Reactor Cycles", Report of 8th WG. IAEA, Vienna (1986).
- [3.1/17] INFCE/Dep/WG 8/19, "Light Water Reactor (PWR) with Th-U Cycle and U Recycle Only", F.R.Germany (1979).
- [3.1/18] INFCE/Dep/WG 8/21, "Conceptual Design of a Quasihomogeneous Pressurised Heavy Water Reactor to be Operated in the Closed Th -²³³U Fuel Cycle", F.R.Germany (1979).
- [3.1/19] INFCE/Pep/WG 8/38, "Advanced Thorium Cycles in LWR's and HWR's", Israel, (1978).
- [3.1/20] INFCE/Dep/WG 8/9, "Data Base for a Candu — PHW Operating on the Thorium Cycle", Canada (1978).
- [3.1/21] INFCE/Dep/WG 8/27, "Feasibility Study and Economics Analysis on Thorium Utilization in Heavy Water Reactor", India (1978).
- [3.1/22] INFCE/Dep/WG 8/39, "The State of the Art on the Thorium Cycle in Italy", (1978).
- [3.1/23] INFCE/Dep/WG 8/55, "Aspects on Thorium Utilization in Heavy Water Reactors", Romania (1978).
- [3.1/24] INFCE/Dep/WG 8/76, "LEU and Thorium Fuel Cycles for the High Temperature Reactor (Once-Through and Recycle)", UK (1978).
- [3.1/25] MUROGOV, V.M., ILYUNIN, V.G., ZININ, A.I., et al., "Metallic fuel fast breeder reactors in the uranium-plutonium and thorium fuel cycle", Proc. Fifth Intern. Conf. Emerging Nuclear Energy Systems: ICENES'89, Karlsruhe, World Scientific, Singapore (1989).

3.2. STATE OF THORIUM USE IN POWER REACTORS

3.2.1. France

The Th-cycle has been a subject of scientific research of considerable interest for the last several years. However, areas of research are still needed, primarily in reactor neutronics:

- the study of core characteristics of HTRs based on Th-Pu fuels;
- the potential change in a toxicity source due to replacement of uranium by thorium in LWRs; and
- the impact of Th-fuel on Pu-burner fast reactor physics.

The Th-cycle potential for fuel waste toxicity reduction, as well as for long lived fission products incineration, has also been studied as part of an overall neutronics analysis of different types of nuclear power systems including traditional reactors and advanced nuclear systems (thermal and fast reactors, accelerator driven systems, etc.). The main goal was to clarify the incentives for the Thorium fuel cycle in light of current concerns about nuclear power (plutonium burning, non-proliferation issues, economic enhancements, fuel waste toxicity reduction, etc.).

3.2.2. Germany

3.2.2.1. Available reactor experience

Long term operational experience with the fuel performance of Th-containing fuel elements has been gained in the AVR and THTR. Further experience has been gained in the critical facilities KATHER at the KFA, Jülich; Proteus at EIR, Switzerland and CESAR at CEA, France (nuclear data, reactivity coefficients etc.).

AVR [3.2/1]

The AVR (thermal power: 45 MJ/s; electrical power: 15 MW) has operated for approximately 127 000 h (mostly with Th-based fuel). Of this, 45 000 h was at He-outlet temperatures of 950 °C. Among other functions, it served as a test reactor for fuel balls with different types of coated-fuel particles [(U, Th) C₂; (U Th) O₂; UO₂; ThO₂, ThO; ThO/Al Si_{doped}). The fuel particles had been coated either with two (BISO) or three (TRISO) layers. All together, about 295 000 fuel balls, with different fuel/breeder loadings, and containing approximately 1360 kg Th, have been used or tested in the AVR. The ²³⁵U enrichment varied between 93 and 10 per cent. The Th-content in individual fuel balls varied between 5 and 10 g per ball, while the U-content varied between 1.1 and 20 g per ball.

THTR [3.2/1 to 3.2/6]

The THTR (750 MJ/s resp. 300 MW) operated for approximately 3 years with an He outlet temperature of 750C. After 3 years it was shut down for local reasons. The core of the THTR consisted of fuel balls with 93 per cent enriched ²³⁵U as driver and Th as breeding material. Each ball contained 0,96 g ²³⁵U and 10 g Th. Due to the premature shut down of the THTR, alternative fuel cycles, with carbide-particles, and separate driver and breeder balls could no longer be inserted and tested. However development work for the fabrication and performance under irradiation had been performed.

Other reactors

In addition to fuel performance data from the AVR and THTR, test reactor data has been obtained from the “Dragon” reactor in the UK. At Dragon, Th-based fuel was successfully tested, and valuable experience was gained regarding nuclear data and fuel performance in block-type fuel elements.

3.2.2.2. Studies and experiments performed

Regarding the application of Th-based fuel in critical experiments, test reactors, and power reactors, numerous studies have been performed for:

- use in existing PWRs (Germany and Brazil) [3.2/7 to 3.2/10];
- MHTRs;
- accelerators (synthetic fuel production from Th); and
- fusion hybrids breeders (synthetic fuel production from Th).

Some of these studies concerned only the use of Th-cycles; others looked at combined Th/Pu- or Th/Pu/U-cycles regarding the optimum burning of Pu or optimum fissile fuel use.

In this context, fabrication and irradiation experiments with six test fuel rods, under simulated PWR-conditions, was performed in the research reactor FRJ-2 in Jülich/Germany. This was to investigate the irradiation behavior of the new Th/U-fuel (Th/5% U) as an advanced nuclear fuel manufactured by novel methods. This fuel was qualified and basic fuel properties were measured. Data were obtained on the fuel performance under irradiation along with information from post-irradiation tests. In addition irradiation of segmented fuel rods containing (Th, U)O₂- and (Th/Pu)O₂- fuel pellets was also performed.

The main conclusion of all studies and experiments was that Th-fuel, ThU or Th Pu, can be used in standard PWRs without changes in plant or core design and without adversely affecting the overall safety features of these reactors. The advantage was a higher Pu-burnup in one cycle and improved use of fissile materials. The know-how and technology, with some restrictions regarding the reprocessing of such fuel, is available.

The latest studies on the application of Th in high temperature reactors (HTRs) concentrated on optimum fissile fuel consumption and the impact on safety of such reactors. The studies showed that, for “mode”, as well as for “closed cycles”, the use of Th resulted in the lowest fissile fuel consumption. The safety features of the HTRs were slightly adversely affected, i.e.,:

- slight decrease of reactivity coefficients (with no noteworthy consequences)
- higher decay heat production in HTRs without active decay heat cooling requires either a decrease in the power density and a reduced unit power, or a change of the core design (e. g., an annular-shaped core with a center graphite column).

3.2.3. India

To start the nuclear power program in India, three-stages were initiated:

- (a) Heavy water reactors,
- (b) Fast breeders, and
- (c) Thorium based reactors.

Serious work on the third phase began 18 years ago with a small reactor physics program. Thorium cycles were analyzed in all the known reactors. The final conclusion was that, from the neutronics point of view, while the molten salt breeder was theoretically the best concept, heavy water reactors were the best among the technologically proven systems. Heavy water reactor technology having already been well established in India, the natural option appeared to be thorium cycles in heavy water reactors. Once the decision was made for thorium in heavy water reactors, the following actions were accomplished:

- (a) The Indian PHWR (pressurized heavy water reactor) is designed so that during the major part of its life there is some power flattening in the central part of the core through differential burnup distribution. In a newly started reactor where the entire core is at zero burnup, the reactor must be de-rated unless other measures are taken to obtain a similar effect. Advantage was taken of this fact to use thorium bundles for power flattening in the initial core of new reactors [3.2/11]. About 500 kg of thorium fuel was thus used for power flattening in the initial core of Kaps unit-1, commissioned in 1993. The core has had 200 full power days of operation and all thorium-containing bundles behaved well.
- (b) The same scheme of power flattening was employed in the second unit and 500 kg of thorium are contained in Kaps unit-2, which attained criticality in December 1994.
- (c) For many years India has followed a policy of thorium irradiation wherever possible. The first scheme to do this was launched many years ago by fabricating thorium rods and placing them in the reflector of the research reactor CIRUS. Since the only neutron flux to which they were exposed was leakage from the reactor, ^{233}U buildup was slow. On the other hand, they did not act as a load on the reactor, so ^{233}U was produced at no loss. These rods were subsequently reprocessed to recover the ^{233}U .
- (d) A ^{233}U -fueled experimental reactor called Purnima-2 was commissioned at Trombay in 1984. This is a homogeneous, zero power solution, reactor experiment using ^{233}U as fuel, light water as a moderator, and beryllium oxide as the reflector. The objective of this experiment was to validate ^{233}U cross-section data; to obtain experience in handling ^{233}U fuel; and to act as a reactor physics prelude to the neutron source reactor KAMINI described below.
- (e) The Kamini research reactor is almost complete and will shortly be commissioned. The reactor is fueled by ^{233}U in the form of ^{233}U -Al alloy fabricated into flat plates, with uranium content of 20 wt per cent. The total ^{233}U inventory of the reactor is 600 g; the coolant-moderator is demineralized light water. There is a reflector of beryllium oxide 20-cm thick, beyond which there is again a water reflector [3.2/12]. This reactor will be used primarily for neutron radiography on active components. One of the chief uses will be to examine the irradiated fuel from the fast breeder test reactor.
- (f) Laboratory studies on the reprocessing of thorium fuels were started early in India. The method chosen was the solvent extraction process [3.2/13]. Later, in the sixties, a pilot plant was set up in Trombay to reprocess the irradiated fuel test rods discharged from the CIRUS reactor. This irradiation is referred to under (c), above. In the seventies, the reprocessing program at the Indira Gandhi Centre for Atomic Research (IGCAR) set up a facility for reprocessing of thorium fuel on a larger scale.

Considerable work has also been done on the recovery and final purification of ^{233}U from irradiated thorium. Reprocessing was done using tributyl phosphate as the extractant. In the initial stages, the emphasis was on the recovery of ^{233}U , while the thorium and fission products were allowed to go into a common solution.

- (g) Fabrication experience on thorium fuels in India has been extensive [3.2/14]. Fuel rods of both thorium oxide and thorium metal were fabricated for CIRUS irradiation, and later, for introduction into the Dhruva research reactor. Thorium fuel bundles of 19-rod clusters, used in Kaps units 1 and 2, were also made here. This fabrication program continues, since every new PHWR to be started will use 35 thorium fuel bundles (~ 500 kg) for power flattening. There are four units on which construction is fairly well advanced, Kaiga 1 and 2, and Raps 3 and 4. A plant for fabricating thorium fuel bundles for this purpose was constructed at the nuclear fuel complex at Hyderabad.

One test cluster of mixed oxides of thorium and plutonium was fabricated and test irradiated [3.2/15] in the pressurized water loop of the CIRUS reactor. Temperature and pressure conditions were similar to those in power reactors. The test cluster was irradiated to a burnup of 18,000 MWd/t, and performed without failure.

For the fabrication of MOX of thorium and ^{233}U , a pellet impregnation method was developed in which ThO_2 pellets of low density are suspended in a high temperature uranyl nitrate bath where they soak up ^{233}U [3.2/16]. At the moment, India has a small program of fabrication of (Th + Pu) mixed oxide fuel pins for irradiation testing.

- (h) A proposal is under consideration to introduce thorium into an Indian reactors in combination with $(\text{U} + \text{Pu})\text{O}_2$ fuel bundles. The proposal is for two kinds of fuel bundles in the core: One kind will contain unenriched thorium; the fuel bundle design will be the same as that currently in use in Raps, a 19-rod bundle 50 cm in length. The other will be a composite fuel bundle, with the outer 12 pins of natural uranium, while the inner seven pins are of UO_2PuO_2 with 0.4 per cent plutonium in the uranium [3.2/17].

The presence of thorium fuel bundles in this scheme serves a double purpose. The composite fuel bundles normally have a discharge irradiation of about 10 000 MWd/t. Due to the reactivity load of thorium, these must be discharged at a lower burnup. But if the residence time of the thorium fuel bundles is very long, the energy extracted from thorium more than compensates for the lost burnup of the composite fuel. This is based on the so-called "once through thorium" (OTT) mode originally proposed by Milgram of Canada. Since residence time of the thorium fuel bundles must be much longer than that of the composite fuel bundles, the two must be in segregated channels.

The other purpose of this scheme addresses the fact that the reactor is presently functioning on natural uranium fuel and is in equilibrium as far as fueling goes. If it is changed from natural uranium to the composite bundle, there will be a transition period during which both types of fuel will co-exist within the reactor. During this stage, there is a possibility of power peaking problems leading to the necessity for de-rating the reactor. The presence of thorium fuel bundles adds one more degree of freedom in the refueling strategy and makes the transition period shorter. A fueling scheme has been proposed to avoid derating during the transition from the natural uranium core to the composite fuel core. Some 14 channels of unenriched thorium were used in this scheme. The proposal is currently under consideration.

- (i) India is presently working on an advanced heavy water reactor (AHWR), especially designed with thorium fuel in mind [3.2/18]. It is a natural extension of the OTT concept, however, with reprocessing of spent thorium and re-fabrication of (Th, ^{233}U) O_2 fuel added. The main constituent of the core is fuel of mixed oxides of thorium and ^{233}U uranium. The system will be of the pressure tube type, with boiling light water as the coolant. The discharge burnup of the (thorium + ^{233}U) MOX can be increased later, depending upon fuel performance limits. The ^{233}U enrichment in the thorium is adjusted so the system will be self-sustaining in ^{233}U . Since the burnup of the (thorium + ^{233}U) oxide is planned to be increased to fuel performance limits, and the ^{233}U enrichment is decided by self-sustaining considerations, it is clear that this lattice would be sub-critical. A few driver zones are provided, which we call seed regions to make the reactor critical. These regions will consist of highly reactive (uranium + plutonium) MOX fuel.

The thorium region will have a positive void coefficient of reactivity. The seed region consisting of a tight lattice of (U + Pu) MOX pins is sufficiently under-moderated that its void coefficient is negative. The design is such that the composite core will have negative void coefficient. An alternative core design for this concept is also under study. This design assumes that the (U + Pu) O_2 region is in the center of each thorium cluster. To take advantage of the harder spectrum of plutonium, it is necessary to have large clusters; a 61-rod cluster is being considered.

This reactor also has total heat removal by natural circulation, and passive safety is ensured by such safety features as gravity driven water pool, isolation condenser, and large volumes of water that can totally submerge the core in the event of an accident.

3.2.4. Japan

Research on the thorium fuel cycle was active in Japan in the 60s and later declined in government-supported institutions and private companies but at the same time, a number of University professors were interested in the thorium fuel cycle. T. Shibata organized a research group on thorium fuel; this was part of the special energy research project under a grant-in-aid of scientific research by the Ministry of Education, Science and Culture from 1980 to 1986. This group conducted significant research on nuclear characteristics, fuel, down-stream chemistry, and biological effects related to the thorium cycle [3.2/19]. This group held a Japan-U.S. Seminar on thorium-fueled reactors [3.2/20].

One year after the completion of the special project, I. Kimura of Kyoto University organized a new cooperative research program on thorium as an energy source in the 21st century. This was adopted and supported by a grant-in-aid of scientific research by the Ministry from 1988 to 1989. After this, a new program on the thorium fuel cycle as a promising energy source in and after the 21st Century was reorganized by Kimura and was supported by that Ministry from 1990 to 1992 [3.2/21]. In 1990, an Indo-Japan Seminar on thorium utilization was organized and many papers based on work, which had been carried out by the above two programs, were presented [3.2/22].

3.2.5. Russian Federation

The use of the thorium based fuel cycle is the subject of a long term R&D program developed in the Russian Federation. This program expands the capabilities of WWER type reactors and the development prospects of fast reactors and is based on mixed uranium-thorium fuel cycles. The program assumes that in parallel to the traditional nuclear power

based on light water reactors of WWER type, development continues on the fast reactor. The fast reactor core is used for transmutation, i.e., for burning plutonium, and trans-plutonium elements (TPEs), produced in the WWERs, and also plutonium released from military applications in the course of the conversion. Thorium is loaded into the LMFR blanket, where its fuel subassembly design and irradiation conditions allow the production of ^{233}U with low ^{232}U content. This ^{233}U is easily extracted from the blanket fuel elements, and can serve as a basis for the uranium-thorium cycle of WWERs without significant change in fuel manufacture.

Realization of this concept not only allows a solution to the goal of gradual reduction of highly radioactive plutonium (civilian and weapons-grade) and TPEs, but also eliminates transportation of plutonium fuel over the country. Since plants for transmutation are concentrated on the sites of the radiochemical plants, this considerably reduces the probability of diversion, or environmental pollution caused by accidents.

In the framework of the R&D program for assimilation of the thorium based fuel cycle, the following basic studies have been made:

- Corresponding calculations for fuel irradiation conditions have been performed for the BN and WWER type reactors. The most important stage of the thorium fuel cycle program is development of specialized fast reactors for plutonium and TPE burning and low-activity ^{233}U production;
- The possibility of ^{233}U production in the BN-350 reactor blanket has been experimentally confirmed, the ^{232}U content being 1–5 parts per million (ppm);
- Thorium samples irradiated in the uranium fuel, heavy water cooled and graphite moderated reactors were tested and studied by radiochemical methods;
- A highly selective method of ^{233}U extraction from the irradiated metallic thorium has been developed and tested;
- Methods have been developed for ^{231}Pa extraction and concentration in milligram quantities for physical studies;
- Manufacturing processes for mixed uranium-thorium oxide, metal and cermet fuels for the WWERs and LMFRs have been developed, and plant arrangements have been considered;
- Preliminary technical and economic evaluations have been made on the feasibility and costs of commercial-scale plant construction for reprocessing irradiated thorium fuel, including isotope purification of ^{233}U from ^{232}U in three stages based on available plants. It has been shown that optimization of technology and production methods could bring the cost of ^{233}U manufacture close to that of plutonium;
- Several scenarios of mixed uranium-thorium fuel cycle have been compared;
- Natural thorium resources in Russia have been investigated. It has been shown that the nuclear industry has nuclear grade thorium in amounts sufficient for the initial stage of adoption of a thorium fuel cycle. However, widespread development and the corresponding thorium production require additional effort;
- The possibility has been considered of starting work on the U-Th fuel cycle using available weapons-grade uranium and plutonium;
- In addition to the analysis of thorium and ^{233}U utilization in traditional reactors (fast and thermal reactors) accelerator systems are also considered in combination with the ^{233}U fueled reactor [3.2/23].

The solution of a key problem deciding to a considerable extent the successful realization of the thorium fuel cycle is the radiochemical reprocessing of irradiated fuel. Two chains for irradiated thorium materials reprocessing are required. They cannot be combined with existing technology for uranium-plutonium fuel reprocessing because of the risk of mutual pollution during reprocessing of wastes, technological scrap, emergency spillage, etc.

One of these chains is the operation for the extraction of low active ^{233}U from the irradiated thorium blankets of LMFRs, and for low active thorium recycling. The second chain is reprocessing highly radioactive spent fuel (thorium-uranium and thorium-plutonium).

The combination of these technologies should be the subject of additional research, although the basic approach to this problem is sufficiently clear. In particular, it is necessary to recognize that the irradiation of thorium-plutonium compositions results in a partial accumulation of TPEs and daughter radio nuclides, including neptunium. Also, the required time for fuel exposure, amounts of tritium and iodine-129 accumulated, the spectrum of gamma-irradiating radio nuclides, and other basic parameters for the radiochemical production, have yet to be determined. Development for radiological safety protection, for regulations related to the NFC manufacturing plant features and for the uranium-thorium fuel cycle equipment operating conditions are an important part of the program.

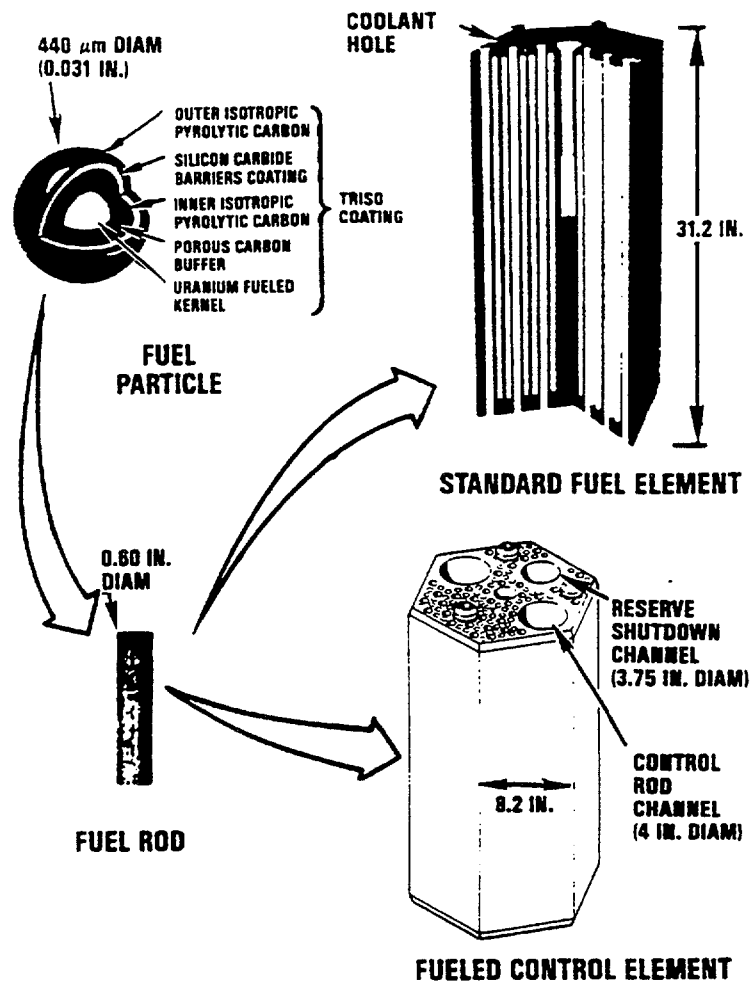

FIG. 3.2.-1. Fort St. Vrain reactor fuel components.

helium-cooled reactor having a thorium and high-enriched uranium (HEU) fuel cycle. The composed of TRISO-coated fuel particles (See Figure 3.2.1) in a carbonaceous matrix. The TRISO coatings on the fuel particles had been shown to be a highly impervious barrier to radio-nuclide release in irradiation tests. Coolant holes, slightly larger in diameter than the

3.2.6. USA

The Fort St. Vrain (FSV) reactor was the most recent operating nuclear power plant in the United States utilizing thorium fuel. FSV was a high temperature, graphite-moderated, fuel holes, were drilled in parallel through the block to allow helium circulation through the fuel element coolant holes and to remove heat generated in the fuel.

The FSV reactor core was composed of 247 columns of fuel elements, with six fuel elements stacked in each column. Figure 3.2.2 shows the location of the columns in the FSV core, surrounded by one row of replaceable reflector elements, in turn surrounded by the permanent reflector blocks. Axial reflector blocks are also located above and below the core.

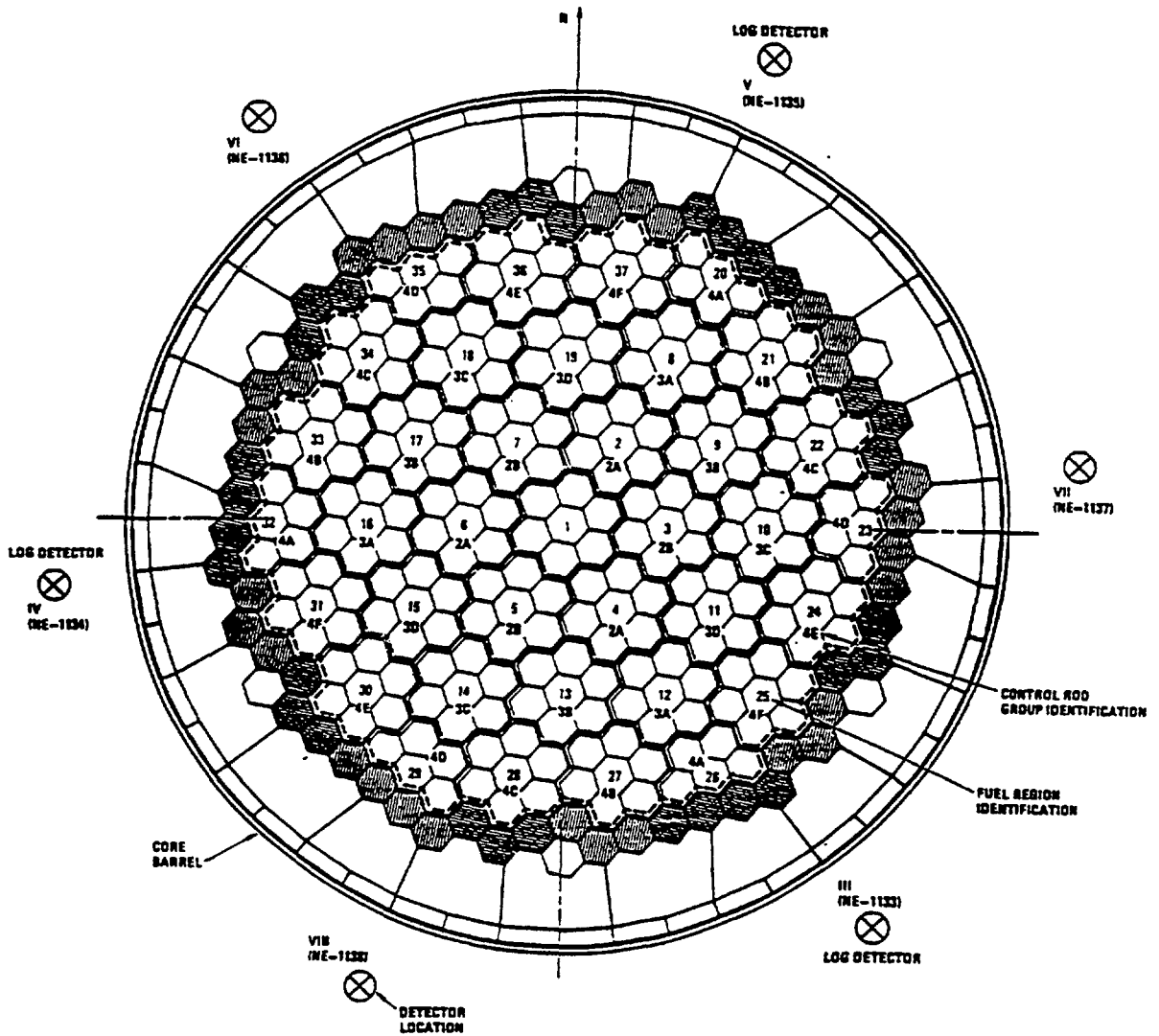

FIG 3.2.-2. Fort St. Vrain reactor core plan view.

The core columns were grouped into 37 refueling regions with the flow in each region controlled by an adjustable inlet flow control valve at the top of the core to maintain a fixed core outlet temperature as power changed due to fuel burnup. The 37 refueling regions contain five or seven columns. About one sixth of the 37 regions were refueled each reactor year. The elements in the central column of each of the 37 refueling regions contained two holes for insertion of control rod pairs, and one hole for insertion of reserve shut down pellets.

The control rods consisted of pairs of metal-clad boronated graphite control rods operated by electric drives and cable drums. The reserve shut down pellets were boronated graphite cylinders with spherical ends that could be dropped into the core to provide an independent and diverse reactor shut down system.

For FSV, 2448 hexagonal fuel elements, 7.1 million fuel compacts and 26 000 kg of fissile and fertile material in TRISO-coated fuel particles were produced. This included almost 25 000 kg of thorium. Performance of the FSV fuel exceeded predictions. It was

irradiated at temperatures greater than 1300C to a maximum burnup in the fissile particles of 16 per cent fissions in initial metal atoms and to a maximum fast neutron fluence of 4.5×10^{25} n/m² with no evidence of significant coating failure.

REFERENCES

- [3.2/1] "UNPUBLISHED DATA from AVR-operators and KFA-experts on Th-based Fuel Elements", March (1995).
- [3.2/2] THTR-SAFETY REPORT, BBC/HRB Report (1975).
- [3.2/3] TEUCHERT, E., "Utilization of the Th-cycle in the High Temperature Reactor", KFA-Jülich (1990).
- [3.2/4] TEUCHERT, E., KFA-Jülich, "Brennstoffzyklen des Kugelhaufen-Hochtemperaturreaktors in der Computersimulation", Jül-2069 (1986).
- [3.2/5] TEUCHERT, E., RÜTTEN H.J., WERNER H., "Reducing the Worlds Uranium Requirement by the Th-Fuel Cycle in HTR's", Nuclear Technology **58** (1982).
- [3.2/6] RÜTTEN, H.J., LEE, C.E., TEUCHERT, E., "The Pebble-Bed HTR as a Net-Breeding Reactor System", KFA-Jülich, Jül-1521 (1978).
- [3.2/7] PEEHS, M., SCHLOSSER, G., Siemens KWU, "Prospects of Th-Fuel Cycles in a Standard PWR", Siemens Forsch- u. Entw. Bericht 15, Nr. 4 (1986).
- [3.2/8] SCHLOSSER, G.J., Siemens KWU, ANDRADE, E.P., "Brazilian-German investigations on Th-utilization in KWU-Type PWR's — Results of Nuclear Core Design", Advanced Light and Heavy Water Reactor Technology (Proc. Tech. Conf., Vienna) IAEA TECDOC 344 (1984).
- [3.2/9] KFA/SIEMENS, KWU/NUKEM/NUCLEBRAS, "Program of Research and Development on the Thorium Utilization in PWR's", (Final Report 1979–1988), Jül. Spez. **488** (1988).
- [3.2/10] SCHLOSSER, G.J., BENDER, D., "Plutonium-Rückführung in Druck- und Siedewasserreaktoren", Atw 40, Jg., Heft 3 (1995).
- [3.2/11] BALAKRISHNAN, K., KAKODKAR, A., "Optimisation of the initial fuel loading of the Indian PHWR with thorium bundles for achieving full power", Ann. Nucl. Energy, **21** No. 1 (1994) p. 1–9.
- [3.2/12] BASU, T.K., SRINIVASAN, M., "Thorium Fuel Cycle Development Activities in India", Edited BARC-1532 (1990).

- [3.2/13] BALASUBRAMANIAN, G.R., "Reprocessing of irradiated thorium — Indian Experience", Proc. Indo-Japan Seminar on Thorium Utilization, 1990;Mumbai (1991) 165.
- [3.2/14] VIJAYARAGHAVAN, R., "Production and fabrication of thorium fuels at BARC", *ibid.*, p.99.
- [3.2/15] ANANTHARAMAN, K., "Loop experiments with thoria based fuels", *ibid.*, p.132.
- [3.2/16] GANGULY, C., "Development of thorium based fuels for water cooled reactor", *ibid.*, p.77.
- [3.2/17] BALAKRISHNAN, K., "Thorium in the Indian HWR", *ibid.*, p.67.
- [3.2/18] KAKODKAR, A., BALAKRISHNAN, K., Advanced heavy water reactor (AHWR), *ibid.*, p.72.
- [3.2/19] SHIBATA, T., KANDA, K., KOBAYASHI, K. (Eds), "Research on Thorium Fuel", SPEY21, Kyoto University (1987).
- [3.2/20] SHIBATA, T., KANDA, K., KOBAYASHI, K. (Eds), "Thorium fuel reactors", Proc. Japan-U.S. Seminar, Atomic Energy Soc., Japan (1985).
- [3.2/21] KIMURA, I., Progress Nucl. Energy **29** (Supplement) (1995) 445.
- [3.2/22] SRINIVASAN, M., KIMURA, I. (Eds), "Proc. Indo-Japan Seminar on Thorium Utilization", Indian Nuclear Soc. and Atomic Energy Soc., Japan (1991).
- [3.2/23] STAVISSKI, YU.YA., KOLESOV, V.F., SHABALIN, E.R., et al., "Multiplying Target of a High Intensity Spallation Neutron Source", Tyal AN PF, preprint No. 0875/94 (1994).

3.3. NON-TRADITIONAL POWER REACTOR CONCEPTS

3.3.1. Melt-proof reactor concepts (Germany)

At several universities (RWTH, Aachen), and research centers (KFA, KFK), studies are underway on the design feasibility options of melt-proof D₂O-reactors or LWRs, including:

- SiC-coated PuO₂-, ThO₂- and/or UO₂-particles, arranged in stainless steel-coated graphite balls and ring-shaped cores (D₂O-reactors);
- SiC-coated PuO₂-, ThO₂ - and/or UO₂-particles arranged in ring-shaped pellets (with or without a graphite matrix) provided with an additional SiC-coating of the pellets and arranged in steel cladding tubes (LWRs).

The goal is to achieve a melt-proof core by a combination of factors:

- burst-proof pressure vessels (to ensure the integrity of the geometry regarding cooling);
- lower power density;
- limitation of the maximum unit power;
- improved heat conductivity due to SiC-coated fuel particles and SiC-coated pellets;
- steel cladding of the fuel balls or fuel rods (higher cladding melting temperature compared to Zircalloy-cladding and regarding the steam/water reaction); and
- provision of additional heat sinks in the primary system (water or low-melting metals) or containment (water).

However, studies on these concepts are in progress and conclusions are not yet available. Another “melt-proof” design is the pebble bed MHTR (200 MJ/s).

3.3.2. Molten salt reactor (Japan)

The concept of the molten-salt reactor (MSR) using a thorium fuel cycle was initially developed at the Oak Ridge National Laboratory (ORNL) in the United States [3.3/1]. This approach was further pursued in Russia, France, and Japan. The MSR concepts cover a wide range of possible designs and applications. They include the molten salt breeder reactor (MSBR), the molten salt converter reactor (MSCR), the actinide incinerating MSR, and the tritium producing MSR. The reactor designs can produce electricity, or provide industrial and domestic heat. The MSBR developed by ORNL is a thermal-neutron breeder operating with molten fluoride ⁷LiF-BeF₂-ThF₄-UF₄ (71.7-16-12-0.3 mol%) as a liquid nuclear fuel. It acts as an electric power-generating reactor using U or Pu as a driver, and Th as breeder material for ²³³U. The basic 1000 MW(e) MSBR design was completed in 1970 [3.3/2, 3.3/3].

It has been demonstrated that MSRs can use both the Th-U and U-Pu cycles, and that they possess a good capability for burning plutonium. Such flexibility originates from some unique properties of the molten-salt fuel compositions, which may consist of heavy and light metal fluorides, such as LiF, BeF₂, ZrF₄, ThF₄, UF₄ and PuF₃. Molten fluorides are very compatible with graphite, and permit the design of a graphite-moderated, single-fluid reactor. The use of fuel in a fluid phase makes possible on-line corrections of the nuclide content in the fuel composition. This may be done by chemical processing, which has been demonstrated experimentally at a laboratory level. Some fission products, like Kr, Xe and semi-noble metals have a low solubility and leave the fuel "automatically". The majority of the fission products may be removed from the fuel and kept out of the core, if necessary.

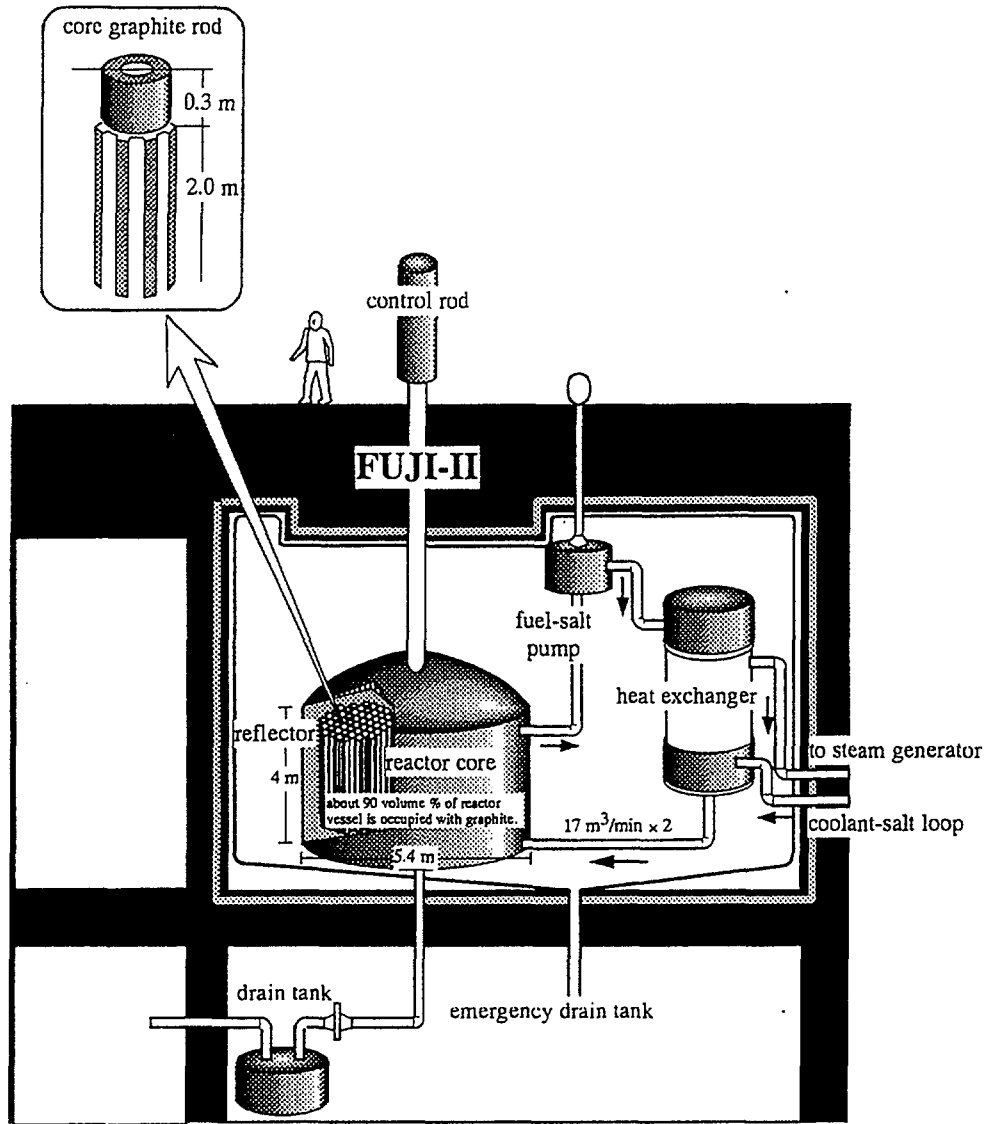

FIG. 3.3.1. Schematic depiction of the MSR-FUJI-II (350 MW(th), 150 MW(e)).

For example, a simplified 350 MW(th) (150 MW(e)) MSR, named FUJI-II, was considered (See Fig. 3.3.1) [3.3/4]. Its features are as follows:

- no core-graphite replacement; and
- no continuous chemical processing except for the removal of gaseous Kr, Xe and T, low-fissile inventory and high conversion ratio.

Calculations suggest a nearly self-sustaining fissile material composition. The reactor vessel is 5.4 m in diameter and 4.1 m in height without flange. The fuel composition is ${}^7\text{LiF}-\text{BeF}_2-\text{ThF}_4-{}^{233}\text{UF}_4$ (71.78-16-12-0.22 mol %), the flow rate is $0.55 \text{ m}^3/\text{s}$ and the average power density is 9.5 kW/liter. The primary system is confined triply by a) vessel and piping wall, b) high-temperature confinement and c) reactor containment.

A pilot-plant of the MSR, a 17.6 MW(th) (7 MW(e)) mini-FUJI, has also been studied. The reactor size is 1.8 m in diameter and 2.1 m in height; the fuel composition is ${}^7\text{LiF}-\text{BeF}_2-\text{ThF}_3-{}^{233}\text{UF}_2$ (71.42-16-12-0.58 mol%) and main piping size is 8 cm in diameter. Facility

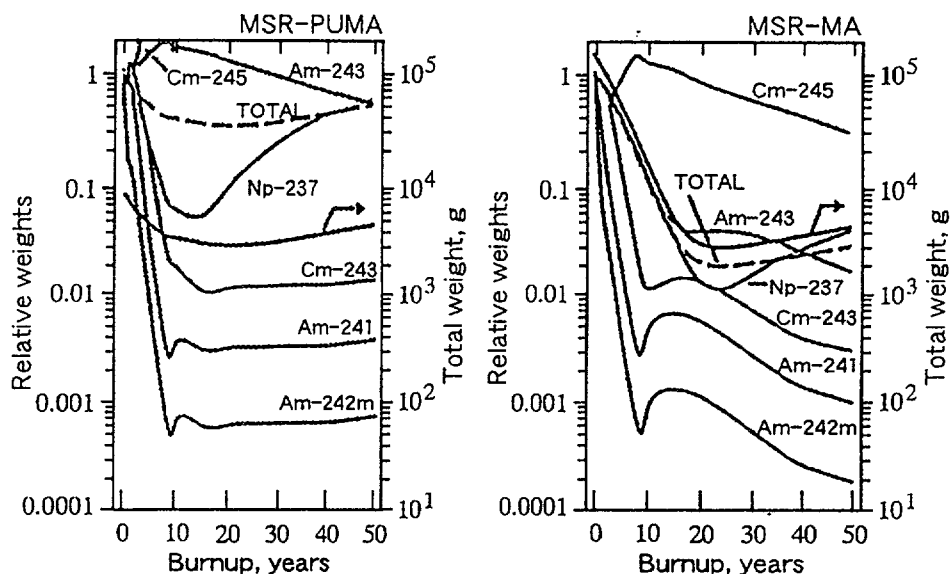

FIG. 3.3.2. Change of MA in MSR-PUMA and MSR-MA during 50 years of burnup.

construction should be straightforward, based not only on the ORNL experience, but also on the significant experience in component development for the liquid-sodium reactor. This was more difficult development due to chemical activity and the thermal shock in sodium systems.

Recently, N. Hirakawa and E. Kasma completed the conceptual design of a molten salt reactor for the incineration of long lived MAs [3.3/5]. They compared two cores of the Fuji-II type; (1) fluoride-type salt ($\text{LiF-BeF}_2\text{-ThF}_4\text{-UF}_4$) +Pu+MA, and; (2) MSR-MA fluoride-type salt + MA. The change in quantities of MA in both cores during 50 years of burnup is shown in Figure 3.3.2. It is seen that the MSR-PUMA decreases total MA by about a factor of two, while MSR-MA is reduced by almost two orders of magnitude, although the quantity of ^{237}Np turns to a slow increase after 20 years. However, they eliminate the continuous separation of Kr, Xe and T, much improving performance. They also investigated the kinetic parameters:

- temperature coefficient;
- void coefficient; and
- effective delayed neutron fraction.

However, it should be noted that in the MSR-PUMA, the MA could be decreased to less than 1/10th when both Kr and Xe are completely removed from the reactor. In this mode, the Pu burning version, FUJI-Pu is effective for Pu-incineration and ^{233}U production to start the thorium fuel cycle [3.3/6].

3.3.3. Aqueous suspension reactor project (Netherlands)¹

The aqueous homogeneous suspension reactor project [3.3/7] successfully carried out in the Netherlands, was intended to try a different technology to attain the same reactor physics objective as the molten salt reactor. The essential principle of both systems is that, being fluid fuel reactors, the fuel can be continuously circulated and subject to on-line reprocessing to remove fission products. The decrease of parasitic neutron losses to fission products results in an increased conversion ratio. This increase will occur for any fuel, uranium or thorium. A

¹ Work done in the Netherlands, summarized and contributed by K. Balakrishnan, India.

small increase in conversion ratio is not significant to the uranium cycle but for the thorium cycle where the conversion ratio is tantalizingly close to unity, this small increase may suffice to permit 100 per cent fuel utilization.

The circulating fuel was conceived as an aqueous homogeneous suspension of (U,Th)O₂ and this project successfully established technological feasibility. The suspension consists of fuel particles 5 microns in size suspended in demineralized water, and circulated by centrifugal pump. The fuel was (22.5%²³⁵U, 2.5%²³⁸U, 75% Th)O₂, and the concentration was about 400 g/L H₂O. The reflector was BeO + graphite and the nominal power of the reactor, 1 MW. The reactor operated for three years and proved satisfactory function of such a system. The areas of anticipated problems, forming the focus of research and development, were the following:

- (1) The particles in the circulating suspension must be homogeneously distributed and maintained at a constant concentration. Unless this is possible, reactivity of the system cannot be controlled. Results show that this requirement can be fulfilled.
- (2) The chemical and mechanical conditions that the particles must fulfill when suspended in water at high temperature.
- (3) Construction problems related to vessel, pumps, valves, flanges, etc.
- (4) Actual operation:
 - (a) Due to the constant impact of the fuel particles, erosion can be a problem, which tends to be concentrated at the bends and branches.
 - (b) Fission fragments escape from the particles and come to rest in the water, directly transferring energy to water. This can lead to a greater degree of radiolysis than in conventional water reactors. A recombinator was used to handle this problem.
 - (c) It is important to remove fission products escaping into water through on-line reprocessing. However, the particles often tend to lump together. When this occurs, fission fragments from one particle may come to rest in a neighbor, and then it is not removed by reprocessing. This degrades reactor performance.

The final conclusion was that all these problems are solvable, and if there is interest, such a reactor could definitely be built and operated.

3.3.4. Gas turbine modular helium reactor (USA)

The GT-MHR is a second-generation meltdown-proof nuclear plant under development, with plans to be operational early in the next century. Plant design evolved from more than 50 gas cooled nuclear reactors that have operated worldwide, coupled with recent advances in gas turbine technology. Five helium-cooled reactors, which operated into the late 1980s, demonstrated the inherent characteristics of a helium-cooled reactor design with inert, single-phase coolant and refractory-coated nuclear fuel. This effectively retains fission products at temperatures up to 1600C (2912F), has high heat capacity with long thermal response times and high temperature stability. These reactors made extensive use of thorium as a reactor fuel.

The GT-MHR is capable of operating with the same safety and high electric power generating efficiency on many different fuel cycles. Both the Peach Bottom 1 and the Fort St. Vrain reactors demonstrated the use of high-enriched uranium fuel with thorium as the fertile

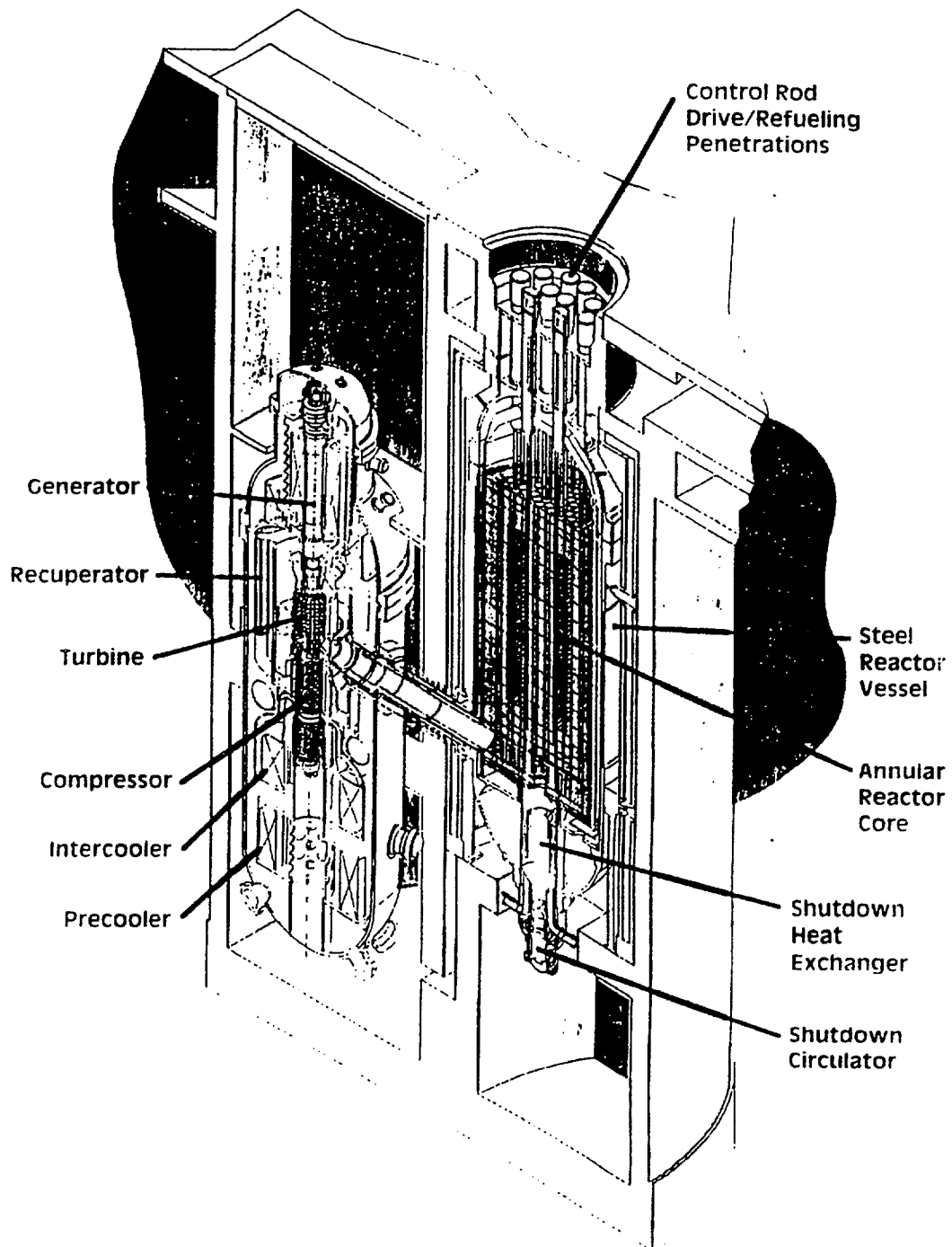

FIG. 3.3.3. GT-MHR power plant configuration.

material (HEU/Th). This fuel cycle produced ^{233}U *in situ* from thorium, with a high conversion ratio, and had excellent economics. Since that time significant increases in uranium enrichment charges in the USA nullified much of the fuel cycle cost advantage of the HEU/Th core. The GT-MHR designs for civilian application utilize low-enriched uranium (<20% ^{235}U) fuel cycle with natural uranium as the fertile material (LEU/U) to meet current U.S. government non-proliferation policies. An LEU/Th fuel cycle has also been designed for this core. This cycle permits better control of core power distribution and a longer operation

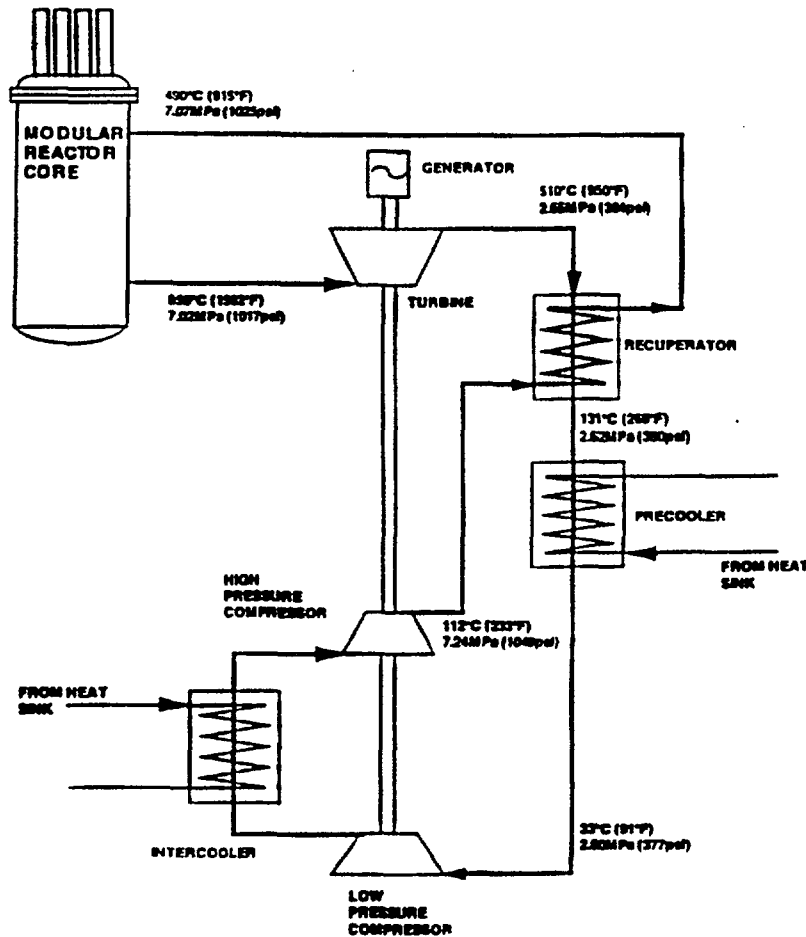

FIG. 3.3.4. GT-MHR process flow diagram.

between refueling because of the excellent thermal neutronic behavior of the bred ^{233}U . However, compared to the LEU/U fuel cycle, the thorium cycle has a 7 to 10 per cent higher decay heat level due to the presence of ^{233}Pa . Under accident conditions, such as loss of coolant pressure or flow, this produces higher peak fuel temperatures than in the LEU/U cycle. Thus, for inherent safety, all other factors being equal, the LEU/U cycle is favored.

The GT-MHR module arrangement is shown in Figure 3.3.3 and key parameters are in Table 3.3.1. Each GT-MHR plant is envisioned to consist of four modules. The GT-MHR module components are contained within three steel pressure vessels, a reactor vessel, a power conversion vessel, and a connecting cross-vessel. All three are sited underground in a concrete containment. The reactor vessel contains the annular reactor core, core supports, control rod drives, refueling access penetrations, and a shut down cooling system. Hexagonal graphite fuel columns containing a mixture of <20 per cent enriched and natural uranium fuel encapsulated in ceramic-coated micro spheres form the reactor core. The reactor vessel is surrounded by a reactor cavity cooling system providing totally passive decay heat removal. The separate shut down cooling system provides backup decay heat removal for refueling and maintenance.

The GT-MHR process flow is shown in Figure 3.3.4. The helium coolant exits the reactor core at 850°C (1562°F) and 7.02 MPa (1017 psia), flows through the center hot duct within the crossduct vessel, and is expanded through the turbine. The turbine directly drives

the electrical generator and high and low pressure compressors. The helium exits the turbine at 510C (950F) and 2.65 MPa (3.84 psia) and flows through the high efficiency plate-fin recuperator to return as much energy as possible to the cycle, then, finally through the precooler to reject heat to the ultimate heat sink. Cold helium at 33C (91F) enters the intercooled two-stage compressor, where it is compressed to 7.24 MPa (1049 psia) at 112C (233F) and passes through the recuperator. Helium at 490C (915F) and 7.07 MPa (1025 psia) flows from the recuperator exit, through the outer annulus within the cross vessel, past the reactor vessel walls for vessel cooling, and finally down through the core to complete the loop.

As a result of inherent characteristics combined with passive design features, the GT-MHR can withstand failure of the primary system boundary with loss of helium coolant in combination with the loss of all forced circulation, without the core reaching temperatures at which significant coated fuel particle failure would occur. Radionuclide releases are significantly less than regulatory limits. Thus, the combination of inherent and passive features provides large margins of safety even for extreme accidents, without melting the reactor fuel.

TABLE 3.3.1. SALIENT FEATURES OF GT-MHR POWER PLANT

PLANT DATA	Plant type	Nuclear gas turbine
	Construction type	Modular
	Reactor type	He-cooled, graphite moderated
	Core geometry	Annular
	Fuel Element Type	Prismatic block
	Power conversion system	Direct cycle helium gas turbine
	Core thermal rating design goal, MW(th)	600
	Module power output, MW(e)	286
	Net efficiency	47.7
THERMAL DATA	Thermal cycle	Recuperated/Intercooled
	Turbine inlet temperature, °C (°F)	850 (1562)
	Turbine inlet pressure, MPa (psia)	7.02 (1016)
	Compressor pressure ratio	2.86
	Compressor efficiency, %	89.9/88.2
	Turbine efficiency, %	93.1
	Recuperator effectiveness	0.95
System pressure loss, (DP/P, %)	7	
COMPONENT DESIGN FEATURES	Turbomachine	Single-shaft rotor
	Compressor type (stages)	Multistage axial flow (14/19)
	Turbine type (stages)	Multistage axial flow (11)
	Generator type	Synchronous
	Bearing type	Active magnetic bearings
	Recuperator type	Compact plate-fin modules (6)
	Precooler/Intercooler type	Finned tube helical bundle
	Pressure vessels	Vertical steel vessels
PLANT STATUS	Design status	Conceptual
	Technology status	State of the art
	Deployment	By 2005

REFERENCES

- [3.3/1] ROSENTHAL, M.W., et al., Nucl. Appl. Tech. **8** (1970) 107.
- [3.3/2] ROSENTHAL, N.M., et.al., "The Development Status of Molten-Salt Breeder Reactor", ORNL-4812 (General Review).
- [3.3/3] ROBERTSON, R.C., et.al., "Concept.Design Study of Single Fluid MSBR", ORNL-4541 (1970).
- [3.3/4] FURUKAWA, K., et.al., "Thorium molten-salt nuclear energy synergetics", J. Nucl.Sci. Tech. **27**, (1990) 1157, and Small Molten-Salt Reactors, Nucl. Engin. Design **136** (1992).
- [3.3/5] KASMA, E., HIRAKAWA, N., Proc. Intern. Conf. Future Nuclear Systems, American Nucl. Soc., **1** (1993) 240.
- [3.3/6] MITACHI, K., FURUKAWA, K., et al., IAEA Technical Committee Meeting on "Unconventional Option for Pu Disposition", Obninisk, Russia (1994).
- [3.3/7] Compiled by KERSTEN, J.A.H., Edited by KEMA, N.V., "Aqueous homogeneous suspension reactor project, Internal Report, Aarnheim (1985).

3.4. STRATEGIES FOR THORIUM USE (PURE THORIUM SCENARIO; COMBINED WITH PU; COMPARISONS)

3.4.1. France

The following conclusions can be drawn regarding the goals in paragraph 3.1.1:

Goal (a):

The toxicity reduction potential for the system consisting of fast reactors (oxide $^{235}\text{U} + ^{232}\text{Th}$) and LWR-type reactors ($^{233}\text{U} + ^{232}\text{Th}$) can be assessed as follows:

- ^{233}U maximum production rate in fast reactors: $\cong 0.6 \text{ t/GW(e)a}$ due to $G \cong 0.6\text{n/fission}$ at equilibrium;
- ^{233}U loading “enrichment” (which allows support to criticality, i.e., $G = 0$ in a mixture with ^{232}Th) is estimated as 10 per cent.

In this case 1 fast reactor (FR) can supply ^{233}U for approximately 5 LWR-loadings (equal reactor powers are considered). The FWT of a system consisting of 5 LWRs (U-Th fuel) and 1 FR is roughly equal to: 0.0032 of the LWR (standard) toxicity for a short time interval (S), 0.057 of the LWR (standard) toxicity for a long time interval (L): that results in 300 (S) and 17 (L) factors for the toxicity reduction compared with the LWR-standard (open uranium fuel cycle) for equal electric power production.

Goal (b):

The toxicity reduction potential for the Pu-burning system consisting of fast reactors (^{239}Pu - and ^{232}Th -loading) plus LWR-type reactors (^{233}U from Fast reactors and ^{232}Th -loading) can be assessed as follows:

- $G(\text{FR}) \cong 1.15 \text{ n/fission}$ and hence 1.1 t/GW(e)a of ^{233}U production

The FWT of a system consisting of 10 LWRs (U and Th fuel) and 1 FR is assessed as 0.022 of the LWR (standard) toxicity for a short time interval, 0.050 of the LWR (standard) toxicity for a long time interval. That is a factor 45 and 20 for the toxicity reduction compared with the LWR-standard (open fuel cycle) at equal electric power production. Thorium as a fertile material produces a negligible amount of TRUs and at the same time, allows minimizing the reactivity excess between reloadings.

Goal (c):

The thorium fuel cycle can be used directly in fast reactors ($G > 0$) or in thermal reactors ($G \cong 0$). For fast reactors at equilibrium, there is some neutron surplus $\cong 0.09 \text{ n/fission}$ for the LLFP-incineration, while a 1400 factor for the FWT reduction, (a 40 factor for the FWT reduction) are calculated for short (S) and respectively long time intervals.

Conclusions

The thorium fuel cycle has useful potential for a reduction in fuel waste toxicity and fuel inventory toxicity of reactors in the range up to 10^4 years after incineration. In a system consisting of a fast reactor ^{233}U producer plus a thermal reactor with ^{233}U -Th-loading (closed

cycle) it can be used for a long period in LWRs, due to abundant Th and to a reduction of NP fuel waste toxicity. The effectiveness of this system is higher than closing the uranium fuel cycle for the LWR for a significant reduction of long lived toxicity.

Thorium in combination with Pu (or TRU) for Pu (TRU) burnout shows a 50/20 (short/long) reduction in fuel waste toxicity compared to the standard LWR, and a 10/3 reduction for the fuel waste toxicity compared with Pu-loaded oxide FRs. A short/long time average was used for numerical assessment. However, the thorium based fuel does not have enough neutrons for the LLFP incineration hence, the thorium fuel cycle generally is more powerful if the LLFP incineration is less important than reduction in the fuel waste toxicity.

3.4.2. Germany

(a) *Pure Th-scenario*

The following studies and experiments have been performed on this subject:

- production of ^{233}U in the Th-blanket of a proton accelerator;
- production of ^{233}U in the Th-blanket of a fusion-hybrid-breeder;
- breeding ^{233}U in a pebble bed MHTR with different loading scenarios [3.4/1; 3.4/2];
- mixed (Th/U) O_2 loading in one ball; and
- two different types of balls:
 - (a) a fuel/driver ball with 20–93 per cent enriched U5 (UO_2 -particles);
 - (b) a breeder ball with Th O_2 -particles.

The breeding ratio for ^{233}U in an MHTR is most favorable in a recycled (reprocessed) option with a conversion rate of 0.71; in case of a once-through-cycle (no reprocessing) the conversion ratio is only 0.57. The respective conversion ratios for large HTRs (requiring active decay heat cooling) would be larger [3.4/3].

(b) *Combined with Pu*

Studies and experiments, on a laboratory scale and reactor scale, have been done for:

- mixed U/Th-fuel, generating Pu during the operation — in HTRs (AVR, THTR, numerous irradiation tests) [3.4/1; 3.4/2]; and
- Th/U and Th/Pu-fuel for PWRs (irradiation and reactor tests) [3.3/4 to 3.3/7].

The conversion ratio achieved in the HTRs was about 0.60. PWR investigations were jointly conducted by Germany and Brazil; (Th/U) O_2 and (Th/Pu) O_2 were investigated as fuel. The maximum conversion ratios, approximately 0.60, were achieved in the Th/HEU-fuel in the recycle option, while the Th/Pu-fuel in a recycle option yielded a conversion ratio of 0.58.

(c) *Comparisons [3.4/1 to 3.4/9]*

Studies and experiments, show the distinct possibility of decreasing the U_{nat} -demand for constant power capacity when using Thorium, whether as pure Th (in breeder elements), or as mixed fuel (Th/U or Th/Pu) in a recycle option, in comparison with pure U-cycles or U/Pu-cycles [3.4/3]. Investigations have further shown, that the use of Th in existing PWRs affects

the reactivity coefficients only slightly, and there is no noteworthy impact on the overall safety features [3.4/4].

In inherently safe MHTRs, Th-based fuel increases short term decay heat production but design modifications of the MHTRs have been identified to overcome these effects.

3.4.3. India

3.4.3.1. Pure Th scenario

Three different cycles have been proposed using thorium; these are:

- (a) the self-sustaining equilibrium thorium cycle (SSET);
- (b) the high burnup, high conversion ratio cycle; and
- (c) the once through thorium cycle (OTT).

In subsection 3.4.3.2 other scenarios are briefly described.

- (a) The SSET

In this cycle, the fuel in the equilibrium stage is thorium ^{233}U , generally in the form of $(\text{Th}, ^{233}\text{U})\text{O}_2$. The ^{233}U content in this mixture is adjusted so that the discharged fuel contains the same amount of fissile material as was present in the initial fuel, subject to reprocessing losses. This cycle is very sensitive to parasitic absorption in the reactor. In the Indian PHWR, this can give a discharge burnup of about 12 000 MWd/t. In light water reactors the value is much lower, closer to 2000 MWd/t. The molten salt breeder gives the best performance in this scenario.

The cycle requires external production of the first charge of ^{233}U . One way to do this is to initiate the cycle using $\text{ThO}_2^{235}\text{UO}_2$. U-233 is then recovered from the discharged fuel and when a sufficient quantity has accumulated, the SSET cycle can be started.

The major shortcoming of the SSET cycle is low burnup. It is not even possible in some reactor systems, i.e., the discharge burnup would be zero. Even the burnup of 12,000 MWd/t, of which the Indian PHWR is capable, is too low for a cycle requiring reprocessing and remote fabrication of the ^{233}U bearing fuel. This leads to a search for cycles with better economics. A promising possibility is use of small amounts of ^{235}U makeup in each cycle. With this, the burnup can be increased as desired.

- (b) The high burnup, high conversion ratio cycle

In this cycle, burnup is increased by some sacrifice on the conversion ratio, however, still keeping it fairly high. When thorium is enriched with ^{235}U for use in the reactor, burnup can be as high as the fuel can tolerate. The spent fuel is not reprocessed.

The main advantage of this thorium cycle compared to an equivalent enriched uranium cycle stems from the fact that as ^{235}U is burnt, ^{233}U builds up, and since ^{233}U is a superior fissile material, the reactivity vs. burnup curve is much gentler with thorium than with enriched uranium. This means that to attain the same discharge burnup, the initial ^{235}U content can be lower in the thorium cycle, consequently, power peaking problems are easier to manage.

(c) The once through thorium cycle (OTT)

The principle of this cycle, originally proposed by Milgram of Canada, is to use plain unenriched thorium along with low-enriched uranium in segregated channels, so burnup can be independently controlled. The presence of thorium acts as a load on the LEU, which must therefore be discharged at a lower burnup. The total energy extracted is the sum of the energy from the thorium and the LEU: As residence time of the thorium in the core increases, the energy obtained from a unit of mined uranium will first decrease, then, after passing through a minimum, will start increasing again, finally becoming higher than it would have, had no thorium been present.

3.4.3.2 Other scenarios

Thorium can be used advantageously in many situations to deal with power peaking problems in reactors. One example is the use for initial power flattening in reactors designed to produce nominal power under some kind of equilibrium fueling. India has already taken advantage of this scheme in two of its reactors, Kaps units 1 and 2, and plans to continue it with future reactors. Indian work in this regard has been described above.

Another use is as a compensating factor whenever nominal power distribution is disturbed. The disturbance could be intentional as in a change from one scheme of fueling to another. Or it could be unintentional, for example, in flow blockage in a channel, or a fuel failure necessitating unplanned refueling of a channel. To use thorium to ease the transition from one fueling scheme to another, Indian designers have worked on a transition from natural uranium fueling of the PHWR to enriched bundle fueling. This was also described above.

Other possibilities exist for thorium cycles to increase fuel utilization. The principle of fluid fuel reactors, in which the thorium fuel spends a large fraction of time outside the neutron flux, in the process favoring the decay of ^{233}Pa to ^{233}U over conversion to ^{234}Pa and ultimately to ^{234}U , can be approximated even in solid fuel reactors to some extent. Thorium is kept in low flux regions of the reactor core to allow ^{233}U to build up, and then moved to high flux areas where the ^{233}U is used for generating power. Such cycles have been investigated in India, though the study is not yet complete.

Thorium also offers interesting possibilities for non-proliferation. If thorium is mixed with ^{235}U and ^{238}U , it can work as a cycle converting the thorium to ^{233}U and fissioning it to obtain energy. At the same time, contamination with ^{238}U renders it resistant to proliferation. More work is needed on such cycles. Studies will be required to determine the amount of ^{238}U to be added so that the ^{233}U produced is proliferation resistant, and at the same time, the quantity of plutonium produced is not significant. Cycles in which thorium is used without the admixture of natural or enriched uranium or plutonium are particularly significant because it has been suggested that whatever long lived actinides are found in spent thorium are actually contributed by such contaminants from the uranium cycle.

3.4.3.3 Thorium combined with plutonium

Plutonium burning has recently become important due to the release of high-grade plutonium in the nuclear heads of weapons and to the realization that large quantities of civil plutonium are stockpiled in countries that have had significant nuclear power programs. Something should be done with this resource; merely stockpiling under "high security" is

hardly desirable. It should be underscored that plutonium is extremely valuable; it is energy in concentrated form. The nuclear industry should oppose tendencies to regard it as "dangerous waste", which should be safely "disposed of somehow". The way to "safely dispose of plutonium" is to use it in a nuclear reactor, a step of great concern to environmentalists.

Thorium can be variously combined with plutonium, depending upon the desired outcome of the cycle. There are many reasons for combining them, but we will first discuss scenarios leading to the best fuel utilization.

The SSET

Plutonium can be used to initiate the SSET cycle described above. Using a thorium plutonium mixture in the first few charges, reprocessing the discharged fuel, and stockpiling the ^{233}U does this, until a quantity sufficient to meet the requirements for the first inventory is satisfied. Thereafter, a small amount of makeup plutonium can be used in the thorium- ^{233}U cycle to increase the discharge burnup of the SSET to more economic levels. The advantage of this cycle is that it maximizes the energy from every unit of plutonium burned, subject only to the constraints of reactor type and the desired discharge burnup. Thus, heavy water reactors, for instance, give more energy/kg than light water reactors. In the same reactor type, one with lower burnup will give more energy/kg than one with higher burnup.

Without reprocessing

The SSET involves reprocessing to obtain ^{233}U and this may not conform with the policies or capabilities in some countries. Here, the cycle must be optimized with the absence of reprocessing as a constraint.

The straightforward cycle in this scenario uses plutonium as the fissile enrichment in thorium. By increasing the plutonium content, very high discharge burnups are possible. High discharge burnups have a number of advantages. One of the most obvious is: if reprocessing is not contemplated, the entire spent fuel inventory must be regarded as waste material, at least in the short term. It is hoped that this will not be in the longer term, because spent fuel, with its content not only of fissile ^{233}U , but of the much larger quantity of thorium, is too precious a resource to be so regarded. But in the short term, it is necessary to store this material, and storage is expensive. There is thus a significant advantage in shrinking the spent fuel inventory and this quantity is inversely proportional to the discharge burnup.

High burnups are also possible with plutonium in a natural uranium mixture. But the physical properties of thorium make possible higher discharge burnups with lower initial enrichment. This not only enhances the energy extracted/kg of plutonium, it makes power peaking problems that come with the fresh fuel easier to deal with.

Another possibility is to mix plutonium with uranium, not with thorium and to fuel the reactor with two kinds of fuel assemblies, uranium-plutonium and plain unenriched thorium. This can also give a degree of freedom that will help obtain better power distribution, since there are two kinds of fuel to work with. Thorium does not produce power when freshly fueled; as ^{233}U builds up, then it starts producing power. These assemblies can be taken to high burnups. When finally discharged, they can be stored pending final decisions on whether or not they need be reprocessed. Studies have shown, that for sufficiently high burnups of thorium fuel, this cycle gives better performance than the simple uranium-plutonium cycle, both in energy extracted and fuel cycle costs.

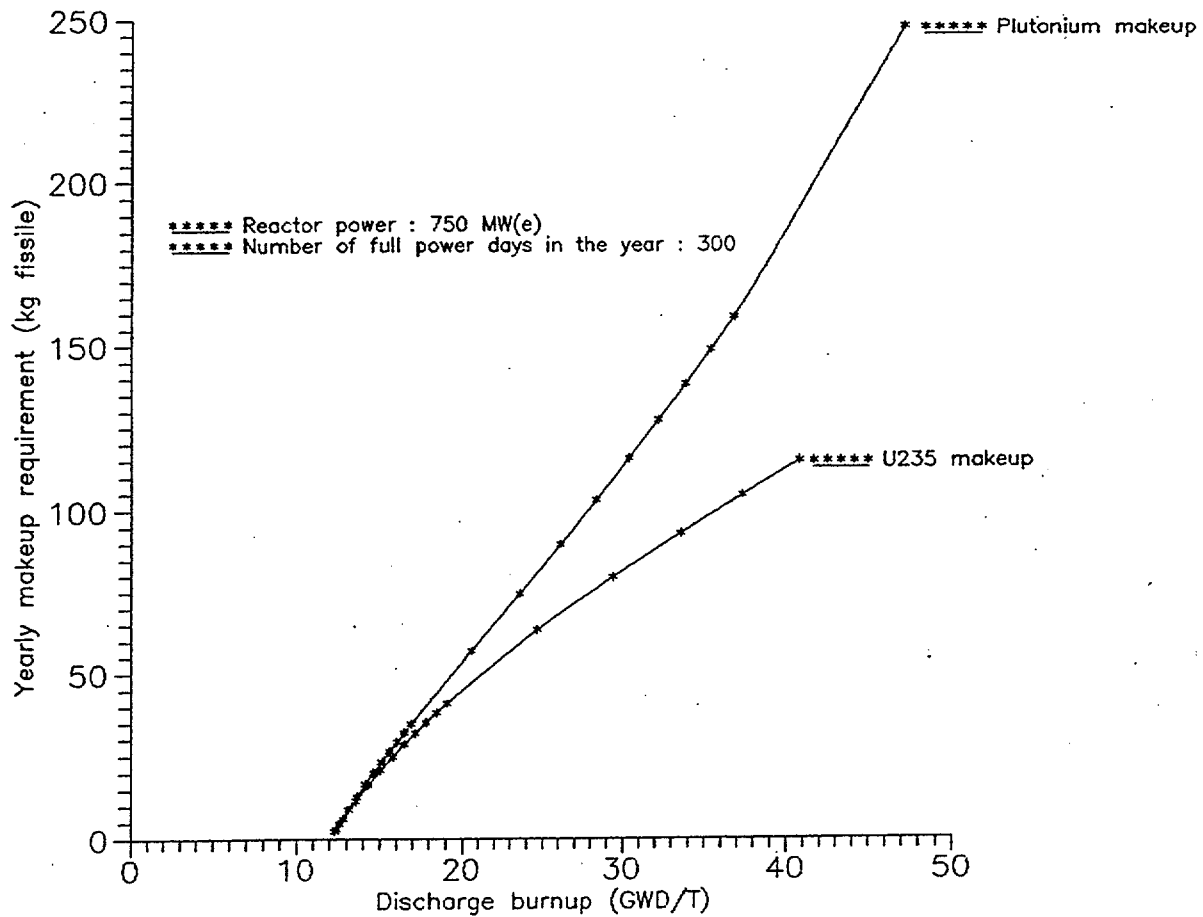

FIG. 3.4.1. SSET cycle in PHWR with external fissile makeup.

Conversion of plutonium into ^{233}U

Thorium combined with plutonium can advantageously convert plutonium into ^{233}U , which is easier to safeguard. Plutonium-thorium fuels can be fabricated with high plutonium contents; if initial contents are high enough, the fresh fuel will be highly reactive and discharge burnup will be large. These large burnups are not achieved by burning plutonium, rather, they result from the conversion of thorium into ^{233}U and its *in situ* burning. The role of plutonium is to provide the first conversion into ^{233}U , and thereafter it basically compensates for neutron loss to fission products. Residual plutonium quantity in the discharged fuel is very small but a fair amount of ^{233}U is present. Thorium-plutonium cycles thus form an efficient vehicle for conversion of plutonium into ^{233}U .

Holding a fissile inventory as ^{233}U rather than plutonium provides better proliferation resistance, since ^{233}U , a hard gamma emitter is more difficult to handle on an irregular basis. Additional safeguard can be built into the cycle by addition of some quantity of ^{238}U to the thorium. This way, while the plutonium is converted into ^{233}U , the ^{233}U becomes contaminated with ^{238}U and from which it cannot be easily separated. The combination of $^{233}\text{U} + ^{238}\text{U}$ produced is good reactor fuel without being weapons grade material.

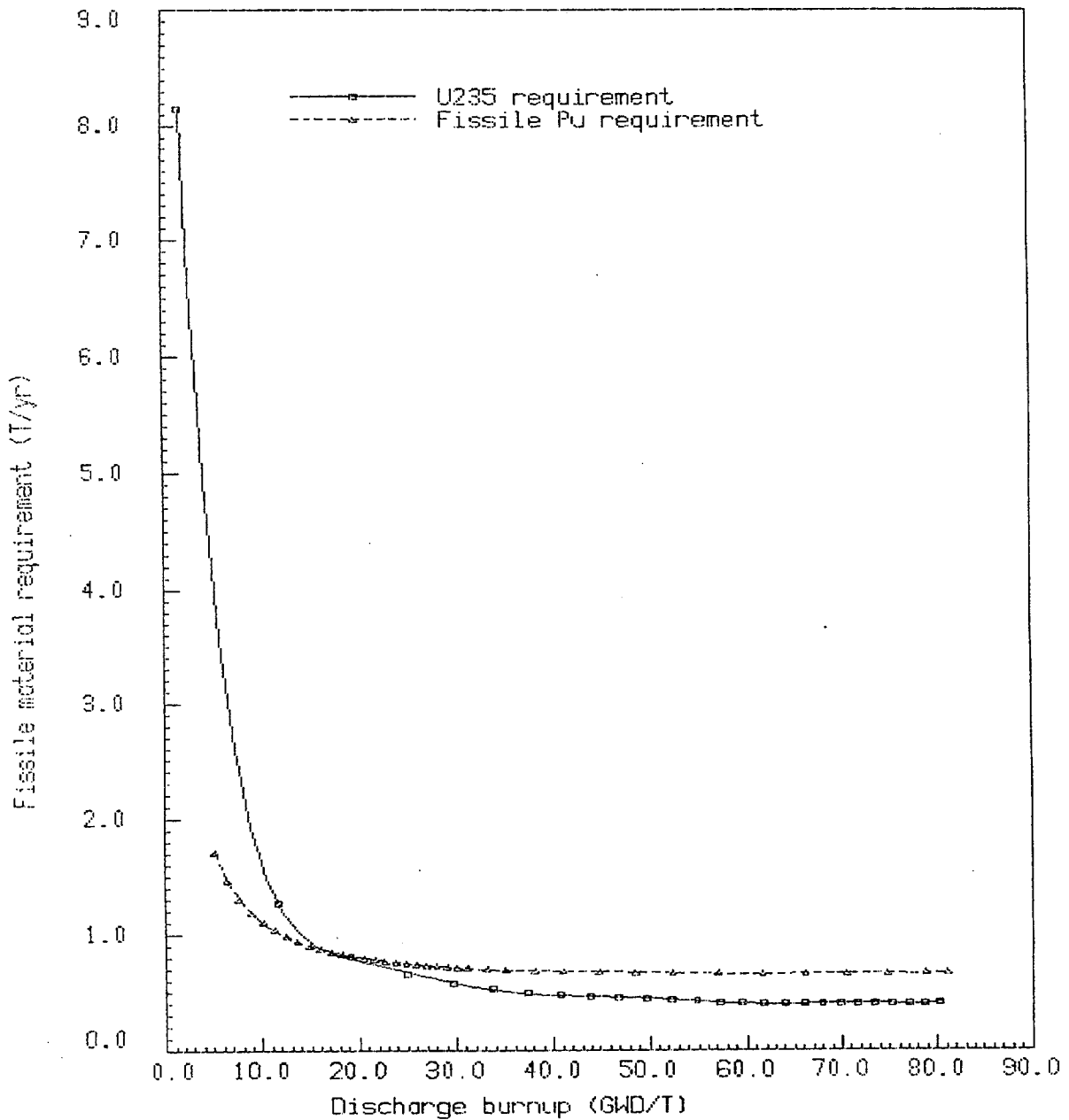

FIG. 3.4.2. Fissile requirement with once through cycle for a 750 MW(e) PHWR.

Comparisons

From the viewpoint of fuel utilization, the best strategy for using thorium is the self-sustaining equilibrium thorium cycle. Additions of small amounts of makeup fissile material have the effect of increasing discharge burnup to adequate levels. Normally, the energy extracted/kg of fissile material is greater when the makeup fissile component is ^{235}U than when it is plutonium. A comparison of SSET with these two fissile materials is in Figure 3.4.1. This means lower fissile content in the fresh fuel with the consequence that power peaking problems with fresh fuel are less serious when working with ^{235}U makeup. For these studies, it was assumed that reprocessing losses would be of the order of 1 per cent.

For the first charge of ^{233}U for the SSET cycle, the two possible routes are the thorium- ^{235}U and the thorium-plutonium route. The amount of mined uranium required for this purpose is nearly double for the plutonium route.

When reprocessing is not considered, fuel utilization is lower. The advantages of this cycle are of a different kind. High burnup thorium cycles with high initial enrichment have better operational flexibility than similar uranium cycles since the initial enrichment needed for the same discharge burnup is lower in the thorium cycles. The discharge burnup can be pushed as high as fuel performance allows (in the THTR, a high temperature gas cooled reactor, discharge irradiations exceeding 100,000 MWd/t were considered). These kinds of cycles can reduce the load on the fueling machines in reactors practicing on-load fueling. They give long cycle times and a lower proportion of outages for refueling in reactors on off-load fueling. This cycle works on either ^{235}U or plutonium fissile feed. Effects of the two are compared in Figure 3.4.2.

Thorium cycles totally uncontaminated by the uranium cycle, like the so-called once through thorium (OTT) cycle, have the advantage that there is no production at all of TRUs. The other advantage is that they form a good way to utilize thorium without using enrichment or any form of concentrated fissile material. In many cases, utilities are shy of changes from tested operating practices. The OTT offers a way of introducing thorium into reactors with a minimum of disruption, and it is hoped some utilities may be persuaded to try it.

In today's political climate, the most interesting thorium cycles are those aiming to convert the world's accumulated stocks of civil and military plutonium into ^{233}U and produce energy during conversion. Using these cycles, it is possible to completely burn up plutonium stocks and replace it with ^{233}U . Indian studies have shown that a 3.6 per cent initial enrichment of fissile plutonium in the PHWR reactor, for example, can give a discharge burnup of 40,000 MWd/t, thus yielding about 1130 MWd/kg of fissile plutonium. The discharged fuel contains only 0.2 per cent fissile plutonium but about 1.3 per cent ^{233}U . Therefore, 1 kg of fissile plutonium is converted into 1130 MWd of energy plus 376 g of ^{233}U . It is possible to develop similar figures for other reactor types [3.4/10].

3.4.4. Japan

3.4.4.1. Plutonium rock-like fuel integrated R&D program (PROFIT R&D program)

The Japan Atomic Energy Research Institute (JAERI) has been promoting basic research on a LWR system that almost completely burns up plutonium, making possible direct disposal. This is the plutonium rock-like fuel integrated R&D program (PROFIT R&D Program). The system consists of the production of rock-like fuels in conventional fuel facilities, burning the fuels in LWR and disposal of spent fuels without further processing. For R&D of the system, a series of studies has been undertaken on the fuels and their burning. It also evaluates and analyses studies of proliferation resistance, environmental safety, technology and economy of the system [3.4/11; 3.4/12].

In the proposed system, it is desirable to design chemically stable fuels to satisfy such requirements as proliferation resistance, economy, and environmental safety. From a comparison of chemical properties and crystal structures of ceramic materials and minerals, some oxide systems with rock-like structures and compositions appear to be available for fuel use. One of them is a $\text{PuO}_2\text{-ThO}_2\text{-Al}_2\text{O}_3\text{-MgO}$ system, consisting of fluorite, corundum and spinel-type phases. The spent fuels become an assemblage of compounds such as fluorite, corundum, spinel, hibonite and alloys. The fluorite-type phase ThO_2 becomes the host phase of the actinide and the lanthanide in fission products. With the presence of excess corundum (Al_2O_3), the alkali and alkaline earth elements are solidified by formation of a hibonite type phase ($\text{CaO}_6\text{Al}_2\text{O}_3$). The spinel $\text{ThO}_2_6\text{Al}_2\text{O}_3$ is the host phase of some transition elements

in the fission products. The noble metals, Ru, Rh and Pd make alloys with Mo and Tc under low oxygen potentials. These phases are analogous to stable minerals.

From survey calculations of burnup on some simplified cell models of LWR, fast reactor (FR) and high temperature gas cooled reactor (HTGR), it is found that PWRs and BWRs can transmute more than 98 per cent of ^{239}Pu and 85 per cent of the total plutonium. The plutonium quality becomes completely poor in the spent fuel in FRs; about 50 per cent of the total plutonium is transmuted but quality in the spent fuels remains high. The initial plutonium inventory in the HTGR is relatively small, and this leads to a smaller plutonium transmutation rate. Thus, conventional LWRs appear most promising for nearly complete burning of plutonium using existing technology. The void reactivity in the $\text{PuO}_2\text{-ThO}_2\text{-Al}_2\text{O}_3\text{-MgO}$ system was calculated to be close to conventional $\text{UO}_2\text{-PWR}$, and the effective delayed neutron fraction β_{eff} was estimated to be small in LWRs. It is therefore necessary to evaluate the reactivity coefficients accurately by performing core burnup calculation and to carry out the safety analysis study to observe the reactor kinetics behavior.

The schedule of R&D consists of three phases, phase I — basic studies, phase II — engineering studies and phase III — commercial operations, as shown in Table 3.4.1.

In the phase relation study of a $\text{PuO}_2\text{-ThO}_2\text{-Al}_2\text{O}_3\text{-MgO}$ system, it was shown that the fuel compound is in a three-phase equilibrium of fluorite + spinel ($\text{MgO-Al}_2\text{O}_3$) + corundum, and the spent fuel in a five-phase equilibrium of fluorite + spinel + corundum + hibonite ($\text{SrO-6Al}_2\text{O}_3$) + alloys. Measurement and evaluation of physico-chemical properties have been started. Irradiation studies of the fuel compounds were also started using JRR-3M with a thermal neutron flux of $2 \times 10^{14} \text{ n/s} \times \text{cm}^2$, hot laboratories and a fuel examination facility. In the reactor burnup and safety analyses, the core burnup calculation was carried out to accurately estimate the Doppler and void reactivity coefficients in PWRs. From the study of plutonium transmutation characteristics by 2-dimensional core calculations, it has been shown that a total of 0.9 ton of plutonium would be denatured every year on the assumption of a 1 GW(e) PWR operating at 80 per cent availability.

Thorium (Th) is used for a Pu burning reactor system as breeding material with the following effects expected:

- (a) negative power coefficients;
- (b) increased use of fissile material due to ^{233}U ;
- (c) mitigation of the reactivity change by burnup; and
- (d) reduction of the amount of long lived transuranics.

The Pu burning reactor system in the present study is a pebble bed type HTGR using Pu burner balls and Th breeder balls [3.4/13]. The Pu ball contains plutonium unmixed with fertile material such as ^{238}U or Th; the Th ball contains only fertile material. The core is randomly loaded with these two types of fuel balls. They are continuously removed from the core. The burnups of Pu balls are evaluated by measuring the strength of γ rays. The Pu balls are reloaded if burnup is under the maximum burnup to be achieved. The Pu balls are discharged from the reactor system as spent fuels if the burnup reaches the maximum value. The excess reactivity necessary for the reactor operation is maintained by loading fresh Pu balls. The Th balls are reloaded as long as the fuel integrity can be maintained.

TABLE 3.4.1. SCHEDULE OF PROFIT R&D PROGRAM

FY	Phase I			Phase II	Phase III
	1994	1995	1996	1997–2002	2003–
ITEMs	[Fundamental R&D] C&R			[Eng. R&D] C&R	[Operation]
(1) Fuel studies	Preliminary exam. --Phys. Chem. Props.---- --Irrad. Exps.----- --JRR-3M-----PIE---			Eng.Irrad.Exps. JMTR/HALDEN Eng.Tests, Advancement	Site specific
(2) Burnup studies	Preliminary exam. --Reactor core design--- --Neutronics characteristics --Safety anal. NSRR---- (full, partial,etc.)			Favorable core Performance Reactor safety Optimization Demonstration	
(3) Assessments	-Proliferation resistance -Economical advantages -Environmental safety			Fine Anal. (site specific)	

The achievable maximum burnup of the Pu ball is about 740 GWd/t_{Pu}. This was evaluated with the following relation:

$$B_n = \frac{2nB_1}{n+1}$$

where

B_n : burnup of spent reactor fuel in which the whole fuels are replaced with n -times of reloading (GWd/t).

B_1 : burnup of spent reactor fuel in which the whole fuels are replaced once (GWd/t).

Burnup of the pebble bed type HTGR (B_n) is twice as much as B_1 because the n can be regarded as infinite due to continuous loading. The value B_1 is calculated with a burnup calculation code for HTGR fuels. The amount of total Pu is reduced to about 20 per cent of the original for a burnup of 740 GWd/tPu as seen in Figure 3.4.3. Plutonium-241 produced decays to ²⁴¹Am with a half-life of 13 years. After decay, only ²³⁹Pu remains in the Pu balls as fissile material. Thus, the total residual fissile material content will be less than 1 per cent of the initial amount of total Pu. For such a small residue of fissile material, there is no incentive to reprocess and/or to reuse it for nuclear fuel or nuclear weapons. The burnup of 109 Gwd/t Th can be achieved for Th balls by reloading and by long duration (about 16 years) in the core.

From the results, it appears that the Pu burner reactor system using Th as breeding material is one of the most promising options for the Pu destruction due to high burnup.

3.4.4.3. Plutonium and minor actinide transmutation by thorium fueled fast reactor

An important issue for prolonging power generation is to confine high level radioactive waste in a fuel cycle system and transmute long lived radioactive minor actinide nuclides such as ²³⁷Np, ²⁴¹Am and ²⁴³Am to shorter or stable nuclides by exposure to neutron flux. It is

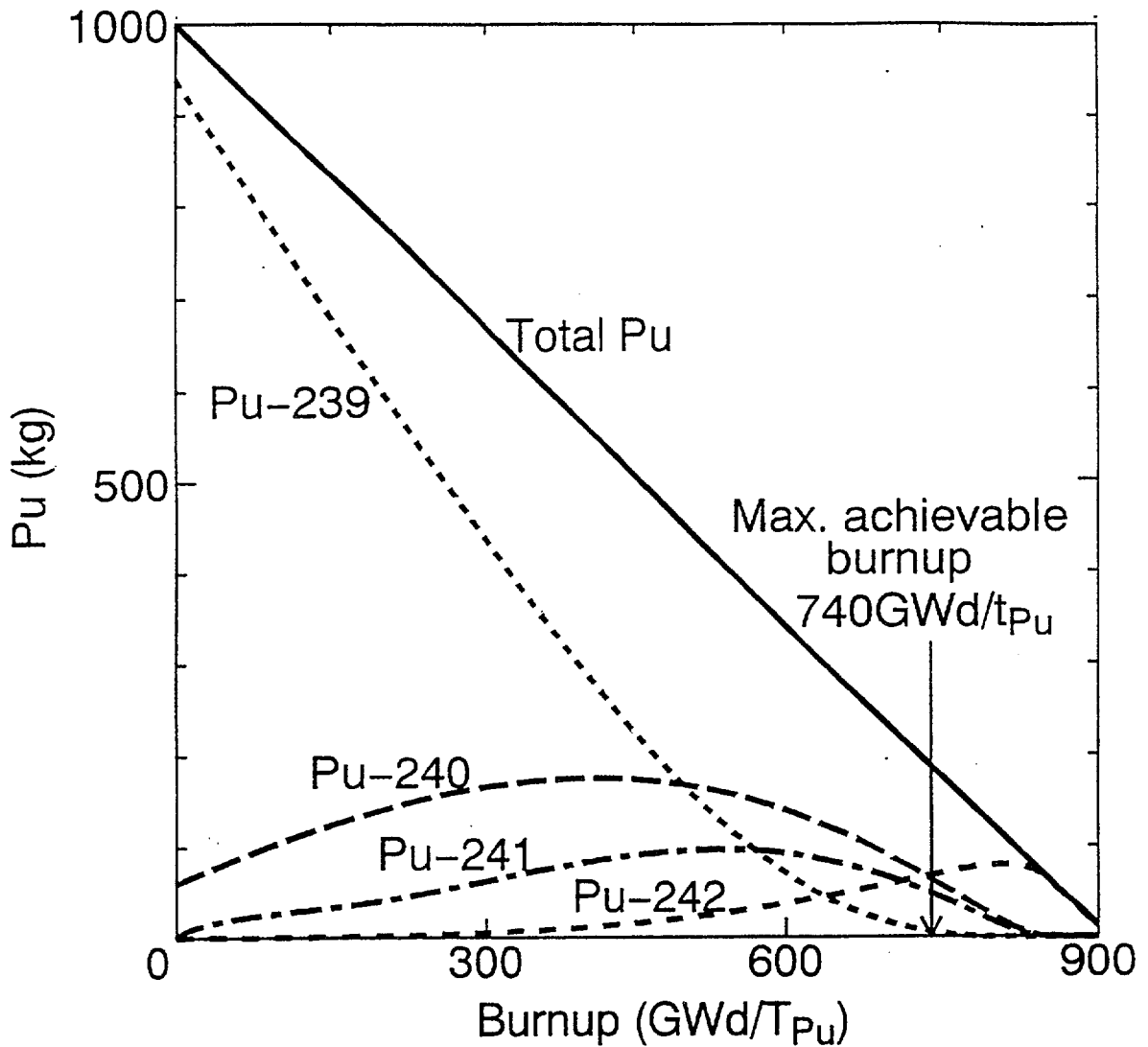

FIG. 3.4.3. Change in amounts of Pu isotopes with burnup of Pu ball (initial amount of Pu is normalized to 1000 kg).

well known that the minor actinide transmutation rate in fast reactors is much higher than that in light water reactors. However, the positive void reactivity is a troublesome drawback from the viewpoint of fast reactor safety. This coefficient increases with the quantity of minor actinides. The use of fertile material ^{238}U produces plutonium and minor actinides. We propose a concept of a thorium nitride-fueled fast reactor as a plutonium and minor actinide burner reactor with very high incineration efficiency and a negative void reactivity [3.4/14].

The long term lead-cooled nitride thorium fuel fast reactor with a thermal power of 1500 MW was designed as a plutonium and minor actinide transmuter. The core performance is shown in Table 3.4.2. The void reactivity reaches large negative values. The plutonium and minor actinides are burned and transmuted for about 0.16 and 0.14 tons per 300 days, and the fissile fuel ^{233}U produced amounts to 0.6 tons per 300 days. This reactor can transmute the plutonium and minor actinides quantities from about 2 and 6 units of the existing PWRs, respectively.

4.3.4.4. Production of ^{233}U fuel in LWR with plutonium fuel

The use of Th/ ^{233}U fuel in light water moderated reactors was studied. It was shown that a conversion ratio greater than 1.0 is feasible in the axially heterogeneous core BWR with an effective volume ratio of moderator to fuel (V_m/V_f) of 0.25, but a large amount of ^{233}U inventory is needed. A study was done, consequently, on the potential of ^{233}U production by using light water reactors to supply the initial ^{233}U loading of Th/ ^{233}U reactors [3.4/15].

Cell burnup calculations were made using a single pin cell model with a PuO_2 and ThO_2 fuel mixture. The moderator/fuel volume ratios (V_m/V_f) of the cell models ranged from 0.25 to 3.0, including the value for conventional PWRs (1.9). The Pu enrichment was adjusted for each cell to achieve the burnup rate of 60 GWd/t. Both reactor grade and weapons grade Pu compositions were considered in the calculation. The reactor grade plutonium composition is that of PWR spent fuels after 33 GWd/t irradiation, and 94 per cent of the weapons grade plutonium is ^{239}Pu .

In Table 3.4.3 the ^{233}U production rates are summarized in terms of tons per GW electric. The tighter the fuel lattice, and therefore the harder the neutron spectrum, the more ^{233}U is produced. In a cell of $V_m/V_f=0.25$, 0.5 tons/GW(e) of ^{233}U are produced per year, while the Pu inventory is about 20 tons/GW(e). The large amount of Pu storage can be used efficiently. Future studies will determine if a fast reactor, with a harder neutron spectrum and a higher power density than LWRs, is promising as a ^{233}U production reactor.

TABLE 3.4.2. CORE PERFORMANCE FOR PLUTONIUM AND MINOR ACTINIDE BURNER REACTOR WITH THORIUM FUEL

Reactor power (MW(th))	1500
Core height (mm)	1000
Diameter (mm)	3550
Blanket height (mm)	300 × 2
Pin diameter (mm)	10.2
Pitch/diameter	1.51
Fuel (Th/Pu/MA) (w%)	14.5/17/10
Burnup (GWd/t)	144
EFPD	3000
Burnup reactivity swing (% k/k)	2.5
Void reactivity (% k/k)	-3.8
Fissile gain	0.93
Pu (t) load/discharge	4.8/3.2
^{233}U (t) Discharge	1.79
MA(t) load/discharge	3.1/1.7
Np-237	1.80/0.83
Am-241	0.87/0.48
Am-243	0.31/0.18
Cm-244	0.078/0.120

TABLE 3.4.3. PU-²³³U CONVERSION IN PUO₂/THO₂ FUELED LWRs

V_m/V_f	0.25	0.8	1.4	1.9	3.0
Pin diameter (cm)	1.23	0.95	0.95	0.95	0.95
Fissile Pu enrichment* (wt % HM)	9.6	9.7	8.1	7.0	6.5
Linear power (kW/m)	15.0	15.0	15.0	15.0	15.0
Discharge burnup (GWd/t)	60.0	60.0	60.0	60.0	60.0
Discharged ²³³ U amount* (t/GW(e))	5.40	2.04	1.51	1.36	1.17
²³³ U production rate* (t/GW(e)/300 full power days)	5.45	2.01	1.50	1.36	1.20
	0.50	0.33	0.26	0.23	0.20
	0.50	0.32	0.25	0.23	0.20

* Reactor grade Pu (upper) and weapons grade Pu (lower)

3.4.5. Russian Federation

3.4.5.1. Realization of a fuel cycle based on thorium and Uranium-233 [3.4/16; 3.4/17]

Realization of the thorium cycle in reactors is only possible through the nuclear transformation of thorium into the fissile isotope ²³³U with the necessity of the chemical reprocessing of irradiated thorium. This means that large scale utilization of thorium and ²³³U requires a closed fuel cycle. Thorium should be irradiated by neutrons in the reactor until an economically profitable amount of ²³³U is accumulated and can be extracted to manufacture nuclear fuel. These processes have specific technological features and problems.

The problem of the uranium-thorium cycle is in its initiation. The high neutron capture in ²³²Th (compared to ²³⁸U) leads to a considerably larger fission materials inventory compared to the usual fuel cycle. Initially the fuel cycle must use ²³⁵U with high enrichment or plutonium. It is the large initial fuel inventory of uranium of high enrichment and the corresponding high expense that have degraded the economics of a uranium-thorium cycle. Now that large amounts of weapon-grade uranium and plutonium are available for use in power reactors, and since significant amounts of civil plutonium are stored, great additional expenditures are no longer necessary and the economics of the uranium-thorium fuel cycle increase appreciably.

3.4.5.2. Utilization of the ²³³U, ²³⁵U, ²³⁸U, Pu and Th based fuel in nuclear reactors [3.4/17 to 3.4/21]

From a physical standpoint, it can be considered advisable to use fast breeder reactors to produce ²³³U as thermal reactor fuel in the long term. The best breeding ratio can be achieved in fast neutron reactors using the plutonium fuel cycle, while the best neutron balance is provided in thermal reactors using the ²³³U-Th fuel cycle. Studies have shown the possibility of such a solution with respect to its physical aspects, based on the so-called combined fuel cycle [3.4/17, 3.4/20, 3.4/21]. Here, thorium loaded into the blanket of fast breeder reactors. can efficiently produce thorium for the fuel cycle of a developing nuclear power.

Summarizing current data, it can be concluded that the introduction of thorium instead of uranium into the fast reactor core causes a deterioration of its reactor characteristics concerning the breeding (specific loading, production rate and doubling time). It also complicates reactor control, connected especially to the accumulation of a long lived (T_{1/2} = 27 days) absorber, ²³³Pa, which is an intermediate product of the ²³³U accumulation.

It follows from analysis of the nuclear and physical parameters of thorium and uranium cycles, that the breeding potential using plutonium (^{239}Pu and ^{241}Pu) in the neutron spectrum of a fast reactor is considerably higher than that of ^{233}U . In addition, the fast neutron effect in ^{238}U is considerably higher than that in ^{232}Th . The thorium-induced maximum contribution to the extra breeding ratio (EBR) possible for the fission spectrum, is 0.125 ± 0.009 . In fast power reactors, the contribution to the EBR caused by the thorium fission does not exceed 0.03 to 0.05, while that caused by the ^{238}U fission can reach 0.3 to 0.35.

At the same time, thorium utilization in fast reactors results in an improvement of some safety features and fuel technological characteristics:

- Fast reactors with thorium and ^{233}U in the core are characterized by larger negative values in the sodium reactivity coefficient. The importance of this becomes most obvious if the assumption is made that reactivity effects caused by changes in the size and geometry are similar for fast reactors with differing combinations of fissile and fertile materials. Control and safety systems can be distinguished by similar reliability characteristics with respect to safety of the reactors, caused by the Doppler and sodium reactivity coefficients. Regarding the Doppler coefficient, calculations show that these values are similar for the uranium-plutonium and uranium-thorium reactors.

The results of a final analysis of relative characteristics available for large power fast reactors in the uranium-plutonium and thorium cycles are shown in Table 3.4.4.

Specific nuclear and physical parameters of ^{233}U , thorium and other elements of the thorium cycle enable improvements in safety, technical parameters and the availability of the light water reactors. As for the ^{233}U , the number of neutrons generated per thermal neutron capture is the highest compared with other fissile elements. This allows an increase in the breeding ratio for thermal reactors with ^{233}U by 0.2 to 0.3, and achievement of self-compensation of the reactivity during such a reactor operation (BR=1.0).

Table 3.4.5 shows the results of studies made at the Kurchatov Institute on the possibilities of an improvement in the technical and economical characteristics for the WWER type reactors when changing to thorium and ^{233}U utilization. The results of studies in Russia and abroad show that, from the standpoint of the fuel utilization efficiency, the amount of power produced from the available natural resources of ^{235}U can be increased several times using a closed thorium fuel cycle for light water reactors.

3.4.6. USA

Many different thorium based fuel cycles have been proposed and evaluated for both LWR and graphite moderated reactors in the USA. The most complete overview was performed as part of the International Fuel Cycle Evaluation (INFCE) program [3.4/22]. Additional studies were performed for LWRs, primarily for PWR type reactors [3.4/23– 3.4/25]; and different thorium cycle scenarios were evaluated for HTGRs [3.4/26, 3.4/27].

These evaluations showed that thorium can be used as the fertile material with any fissile material, i.e., ^{233}U , ^{235}U , or ^{239}Pu . All combinations have been studied including once through, partial and full recycle modes. From these studies it is clear that the thorium fuel

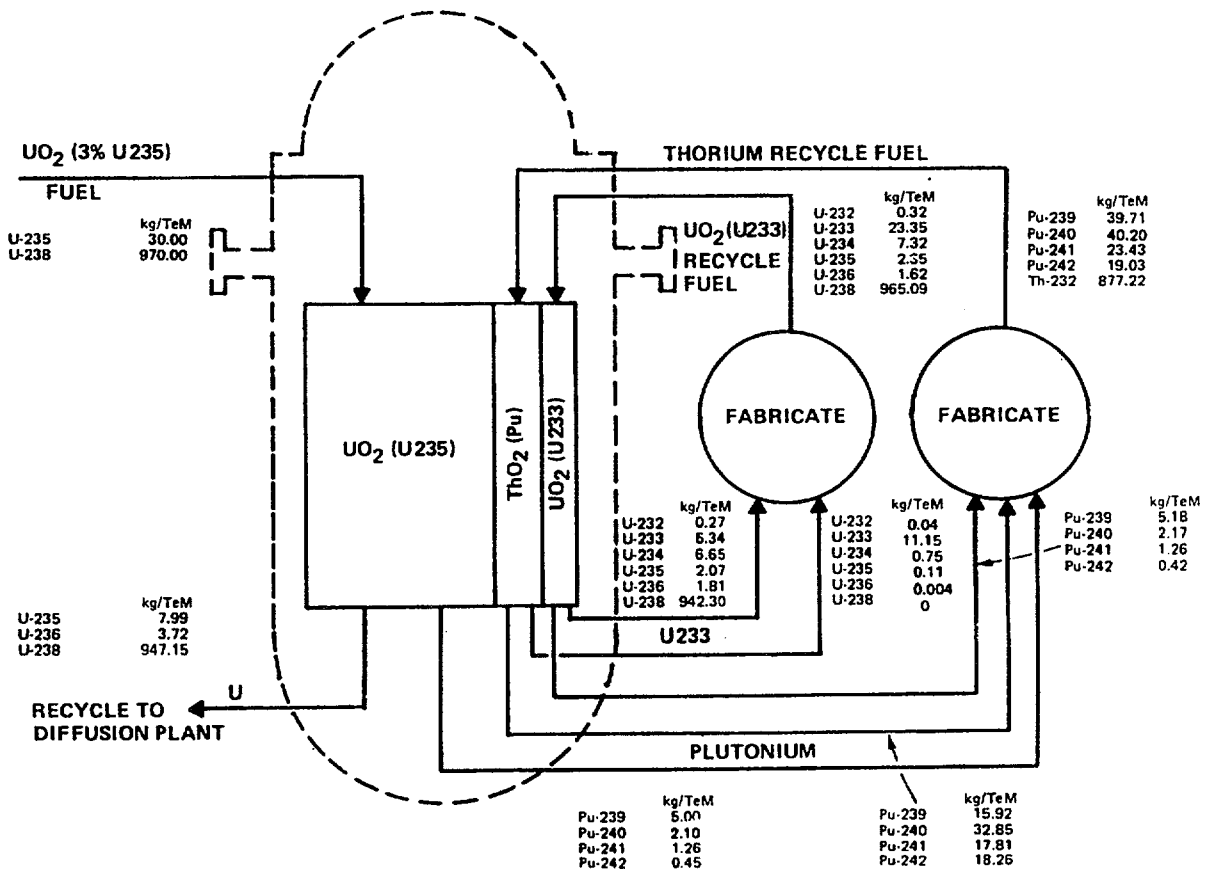

FIG. 3.4.4. Possible LWR thorium/plutonium fuel cycle.

TABLE 3.4.4. BREEDING CHARACTERISTICS OF LARGE POWER BN TYPE FAST REACTOR FOR DIFFERENT FUELS IN THE URANIUM- PLUTONIUM AND THORIUM FUEL CYCLES [3.4/17]

Fuel type	Initial loading (kg/MW(e))	Surplus production of Pu or ²³³ U (kg/MW(e)-years)	BR	T ₂ (years)* T _{ext} =1 year
Oxide:				
PuO ₂ -UO ₂	3.1-3.6	0.23-0.245	1.25-1.35	Ç15
²³³ UO ₂ -ThO ₂	3.3-3.8	0.034-0.043	1.04-1.10	100-110
Carbide:				
PuC-UC	2.6-2.9	0.33-0.35	1.42-1.48	Ç10
²³³ U-ThC	2.9-3.3	0.036-0.058	1.05-1.11	70-90
Metal:				
²³⁸ U-Pu	2.6-3.1	0.40-0.60	1.63-1.80	4-6
²³³ U-Th	2.9-3.3	0.088-0.12	1.10-1.15	25-50

* T₂ = Doubling time, T_{ext} = time before reprocessing

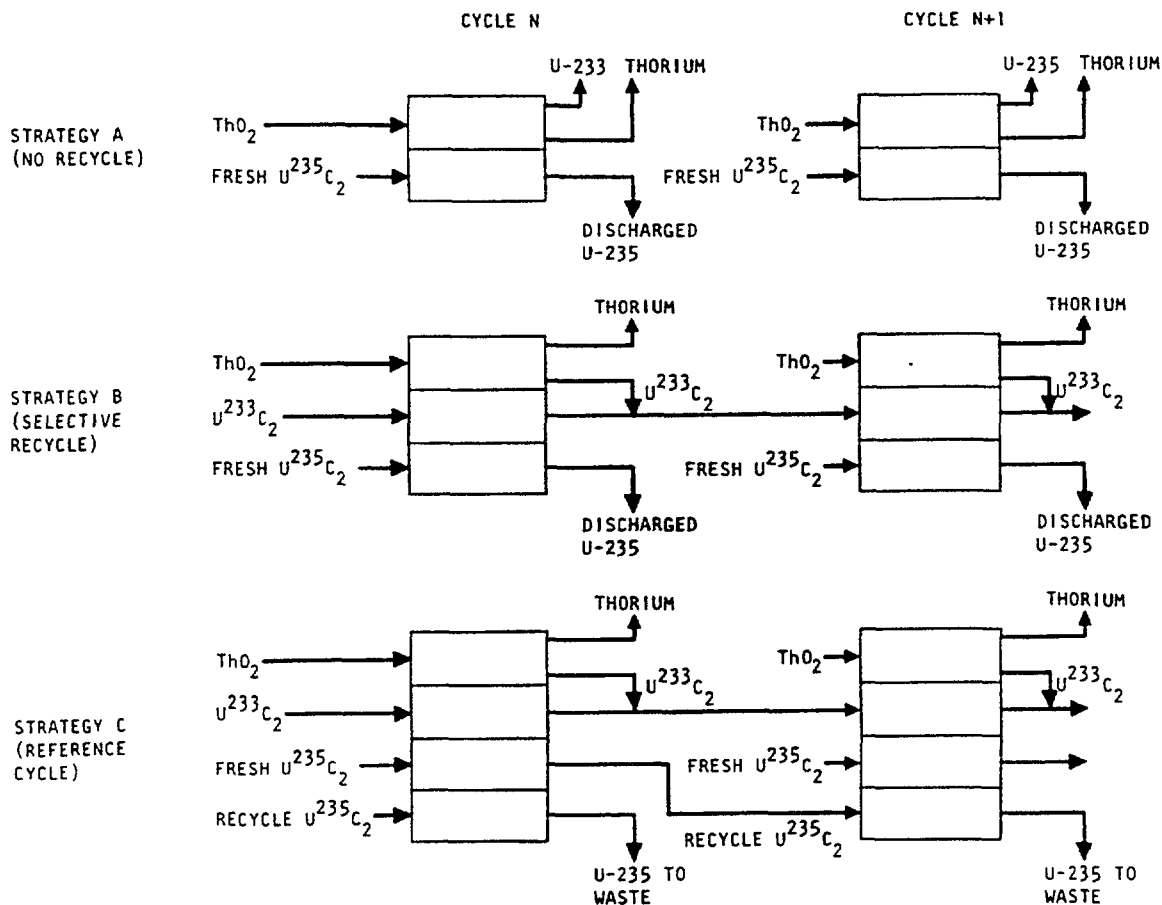

FIG. 3.4.5. HTGR thorium fuel cycle options.

TABLE 3.4.5. TECHNICAL INDICES OF NPP WITH WWER TYPE REACTOR WITH DIFFERENT FUELS

NPP index	WWER-1000		Advanced Design	
	UO ₂	PuO ₂ -UO ₂	Th- ²³⁵ U	Th- ²³³ U
Fuel type				
Fuel isotope loading, t/GW(th)	0.685	0.702	0.710	0.520
Annual discharge of fissile isotopes, t/GW(th) per year	0.314	0.326	0.310	0.240
Annual consumption of fissile isotopes t/GW(th) per year	0.167	0.173	0.058	0.022
Breeding ratio	0.53	0.52	0.83	0.94

cycle can be adapted to almost any external constraints. For example the Th/²³³U fuel cycle can be operated in a thermal reactor-breeding mode in both LWRs and HTGRs if energy and resource demand warrants it and uranium ore prices are high. The Th/Pu fuel cycle can be used to destroy plutonium from both weapons and standard LWR discharge fuel, while extracting the maximum amount of energy from the plutonium. The ²³³U produced in the Th/²³³U fuel cycle can easily be denatured to minimize proliferation and diversion risks, if that is demanded. As an example, Figure 3.4.4, taken from [3.4/25], illustrates a Th/Pu fuel cycle for a PWR with low enriched uranium makeup.

Many thorium fuel cycle strategies have also been evaluated for HTGRs. For example, Figure 3.4.5 illustrates three possible Th/²³³U fuel cycles with ²³⁵U makeup including no recycle, full recycle, and selective recycle to minimize the neutronic and economic penalty of ²³⁶U buildup. If proliferation concerns are important, then an LEU/Th cycle can be adopted where the uranium is enriched to less than 20 per cent in ²³⁵U. The INFCE evaluation showed that this cycle, even in a once through mode, is preferred over the straight LEU cycle both from the standpoint of resource efficiency and fuel cycle economics. The LEU/Th fuel cycle reduces U₃O₈ requirements anywhere from 9–19 per cent compared to the LEU only cycle, depending on the specific cycle design selected.

REFERENCES

- [3.4/1] RUTTEN, H.J., TEUCHERT, E., “Advanced safety features of pebble-bed -HTRs with thorium utilization”, ANP 92, Proc., Vol. 1, Tokyo, Japan (1992).
- [3.4/2] TEUCHERT, E., “Brennstoffzyklen des Kugelhaufen- Hochtemperaturreaktors in der Computersimulation”, KFA-Jülich, Jül-2069 (1986).
- [3.4/3] TEUCHERT, E., RÜTTEN, H.J., WERNER, H., “Reducing the worlds uranium requirement by the Th-fuel cycle in HTR’s”, Nucl. Technol., Vol. 58–9 (1982).
- [3.4/4] SCHLOSSER, G.J., ANDRADE, E.P., “Brazilian-German Investigations on Th-Utilization in KWU-Type PWR’s — Results of Nuclear Core Design”, IAEA Tecdoc 344, IAEA, Vienna (1984).
- [3.4/5] PEEHS, M., SCHLOSSER, G., “Prospects of Th-fuel cycles in a standard PWR”, Siemens Forsch- u. Entw. Bericht 15, Nr. 4 (1986).
- [3.4/6] KFA/SIEMENS, KWU/NUKEM/NUCLEBRAS, “Program of Research and Development on the Th-Utilization in PWR’s”, (Final Report 1979–1988), Jül. Spez. 488 (1988).
- [3.4/7] SCHLOSSER, G.J., BENDER, D., “Plutonium-Rückführung in Druck- und Siedewasserreaktoren”, Atw 40, Jg., Heft 3 (1995).
- [3.4/8] TEUCHERT, E., “Thorium Utilization in HTR’s with Advanced Safety Features”, KFA-Jülich (1991).
- [3.4/9] RÜTTEN, H.J., TEUCHERT, E., “Advanced Safety Features of Pebble- Bed HTR’s with Th-Utilization”, KFA-Jülich (1992).
- [3.4/10] BALAKRISHNAN, M.R., “Growth scenarios with thorium fuel cycles in pressurised heavy water reactors“, Proc. Indo-Japan Seminar on Thorium Utilization, 1990, Mumbai (1991) 62.
- [3.4/11] AKIE, H., et al., Progress Nucl. Energy, **29**, (Supplement) (1995) 345.
- [3.4/12] AKIE, H., et al., Nucl. Technol., **107** (1994) 182.
- [3.4/13] YAMASHITA, K. et al., J. At. Energy Soc. Japan, **36** (1994) p.865–868.
- [3.4/14] TAKANO, H., et al., “Design study for inherent safety core, aseismicity and heat transport system in lead-cooled nitride-fuel fast reactor”, Proc., International Topical Meeting on Advanced Reactor Safety, ARS’94, Pittsburg, USA (1994).

- [3.4/15] AKIE, H., et al., "Water moderated Th/²³³U Breeder Reactor", Proc. Int. Specialists' Meeting on Potential of Small Nuclear Reactors, Tokyo, H. SEKIMOTO, (Ed.), Elsevier Science Publishers, (1992) 197.
- [3.4/16] MUROGOV, V.M., TROYANOV, M.F., SHMELEV, A.N., "Thorium Utilization in Nuclear Reactors", Moscow, Energoatomizdat (1983).
- [3.4/17] LEYPUNSKI, A.J., MUROGOV, V.M., TROYANOV, M.F., "Combined fuel cycle in power fast reactors", Physical Issues of Nuclear Reactors, Moscow, v.1 (1968) p. 20–37.
- [3.4/18] TROYANOV, M.F., "Today's state of the art of fast reactors in the Soviet Union", Presented at the Royal Society Discussion Meeting on the Fast Neutron Breeder Fission Reactor 1989.
- [3.4/19] KOCHETKOV, L.A., MATVEEV, V.I., MUROGOV, V.M., TROYANOV, M.F., "Advanced BN-type fast reactor concept under new conditions of nuclear power engineering development", ENC'90: ENC/ANS, Framatome Conference and Exhibition Euroexpo, Lyon, France, Vol.2 (1990) p. 802–806.
- [3.4/20] MUROGOV, V.M., VAN'KOV, A.A., ILYUNIN, V.G., "Prospects of Metallic Fuel Utilization in Fast Reactors", IPPE-1913, Obninsk (1988).
- [3.4/21] MUROGOV, V.M., ZININ, A.J., ILYUNIN, V.G., RUDNEVA, V.YA., "Fast Reactors with Different Fuels in Uranium-Plutonium and Combined Fuel Cycle", IPPE-1920, Obninsk, (1988).
- [3.4/22] INFCE Working Group 8, "Advanced Fuel Cycle and Reactor Concepts ", INFCE/WG.8/USA/DOC 12-A, November 1978 and 13-A (1979).
- [3.4/23] MATZIE, R. A., REC, J.R., "Assessment of Thorium Fuel Cycles in Pressurized Water Reactors", CE Power Systems TIS-5114 (1976).
- [3.4/24] MATZIE, R. A., REC, J. R., TERNEY, A.N., "An Evaluation of Denatured Thorium Fuel Cycles in Pressurized Water Reactors", CE Power Systems TIS-5116 (1977).
- [3.4/25] "Assessment of Thorium Fuel Cycles in Pressurized Water Reactors", EPRI Report NP-359 (1977).
- [3.4/26] TURNER, R.F., et al., "Analysis of Nuclear Systems Satisfying U.S. Energy Needs", GA-A14848 (1978).
- [3.4/27] FISCHER, P.U., et al., "The Adaptability of the HTGR to Various National Requirements", GAMD-8299 (1967).

3.5. NUCLEAR DESIGN INCLUDING COMPUTER CODES AND THEIR VALIDATION (NUCLEAR DATA; NUCLEAR CODE DESIGN; NUCLEAR FUEL CYCLE STUDIES REGARDING FUEL CONSUMPTION, SAFETY ASPECTS)

3.5.1. France

Nuclear data for ^{232}Th and ^{233}U in the JEF and ENDF/B cross section data sets have been reviewed and verified; and possible improvements in future data set iterations have been identified.

3.5.2. Germany (in co-operation with Brazil, Switzerland, United Kingdom)

3.5.2.1. Nuclear data

The consensus of experts at universities, research centers, and industry is that the required nuclear data for Th-, Th Pu-, Th U-, or Th Pu U- fuel cycles are available (basic cross sectional libraries and specific libraries for defined spectra), as are computer codes for nuclear design. Nuclear data and computer codes have been validated by critical experiments (e.g. KATHER at KFA, CESAR at CEA, Proteus at EIR), by test elements in research reactors and by reactor operation (AVR, THTR, Dragon) [3.5/1 to 3.5/5].

Within a cooperative program with Brazil and Germany (Nuclebras/CDTN, Siemens/KWU, Nukem, KFA Jülich) detailed investigations were performed on a standard 1300 MW(e) PWR using (Th, U)O₂ and (Th, Pu)O₂ fuel. The results showed that these fuels can be inserted in 3 and 4 cycle operating schemes without modification in the fuel assembly or core design [3.5/6 to 3.5/9].

The production of actinide waste from the U/Pu fuel and from the U/Th fuel is compared in Figure 3.5.1. This shows the toxicity of the fuel as a function of storage time, from a typical LWR and an HTR, using the Th/U-cycle, with both reactors recycling 99 per cent of the uranium, plutonium and thorium, respectively. The actinide toxicity of the Th-based fuel is significantly lower (by a factor of 10) compared to the U/Pu fuel, but with some increase in toxicity level (as against the end of reactor operation) after 10⁴ to 10⁶ years. Analysis of the differences in the amount and time dependency of the waste toxicity is given in Figure 3.5.2. It illustrates the relative contribution of the most important actinides, including their decay products, for both fuel cycles. In the U/Pu cycle, toxicity is dominated by the Am and the Cm isotopes. For decay times larger than 10⁵ years, Np and its decay products will dominate the toxicity.

In the U/Th cycle only a small amount of Am and Cm is produced. However, after an extremely long disposal time the waste toxicity increases, reaching a maximum after about 10⁵ years. As shown by the right hand part of Figure 3.5.3, this increasing toxicity is nearly exclusively determined by the loss of uranium during extraction. Thus, further minimization of the waste toxicity requires methods differing in principle for the two fuel cycles. In the U/Pu cycle, further reduction of toxicity requires extraction of the elements Am and Np, in addition to U and Pu; for the U/Th cycle an increase in the degree of the extraction of uranium, exclusively, has a significant effect on the reduction of waste toxicity. Figures 3.5.3 and 3.5.4 illustrate the effect of such a procedure. For the thorium cycle it is obviously advantageous that reduction of the long term waste toxicity (i.e., by 2 orders of magnitude) can be achieved just by optimizing the extraction process for uranium and that it is unnecessary to extract transplutonium elements as is the case for the U/Pu cycle.

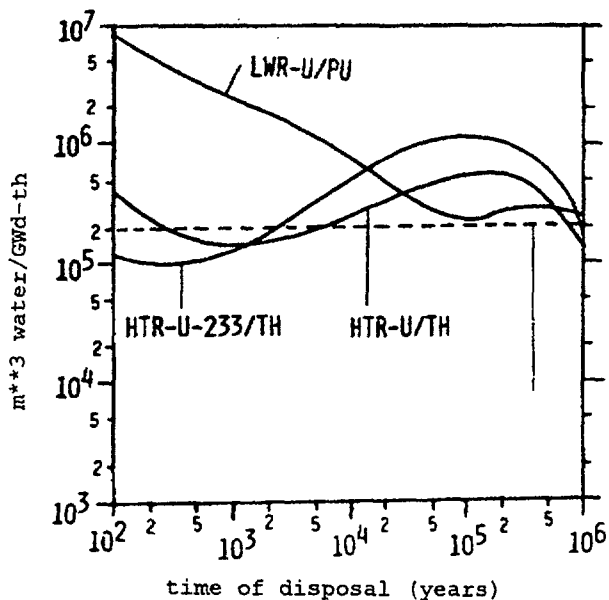

FIG. 3.5.1. Comparison of the production of actinide waste for different fuel cycle in dependence on the storage time (1% losses at reprocessing).

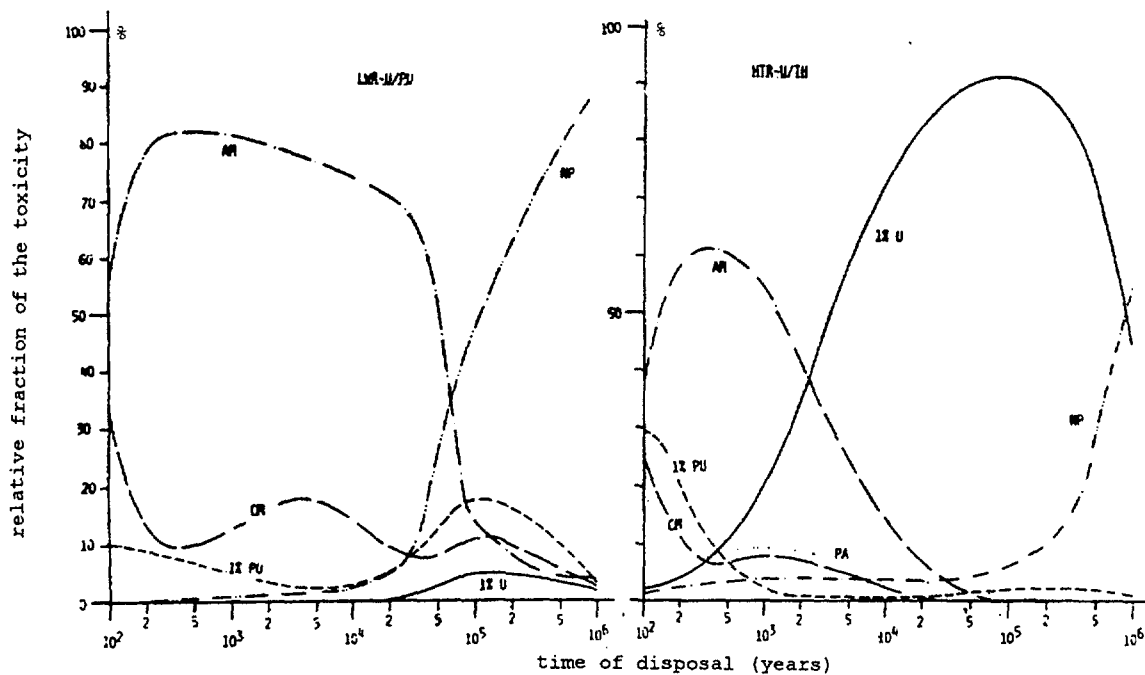

FIG. 3.5.2. Time dependency of the waste toxicity (most contributing isotopes) for different fuel cycles.

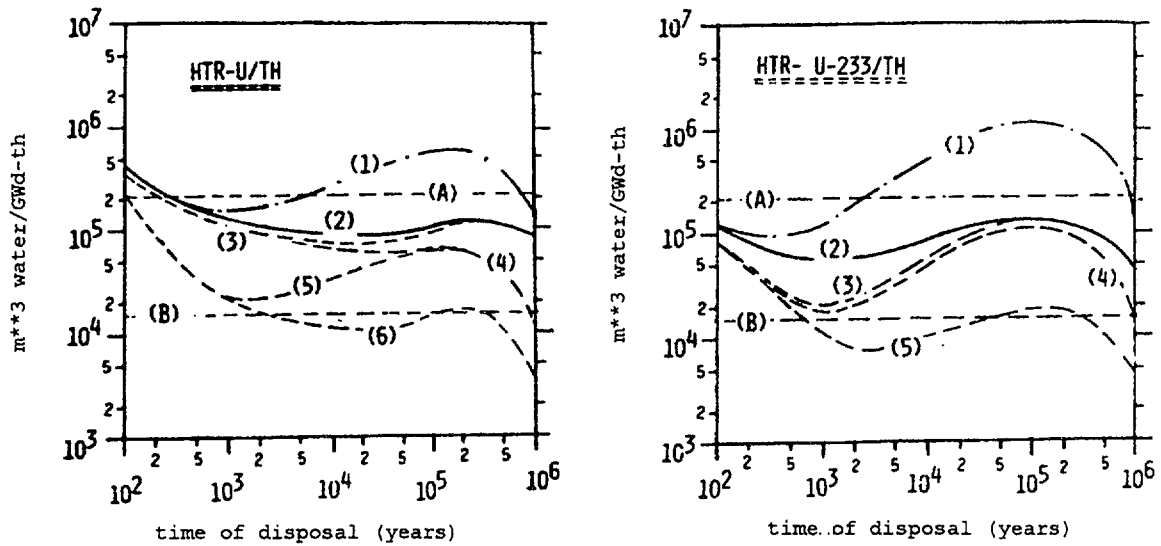

FIG. 3.5.3. Potential for limiting the toxicity of the heavy metal waste at the U/Th-cycles by applying different reprocessing strategies.

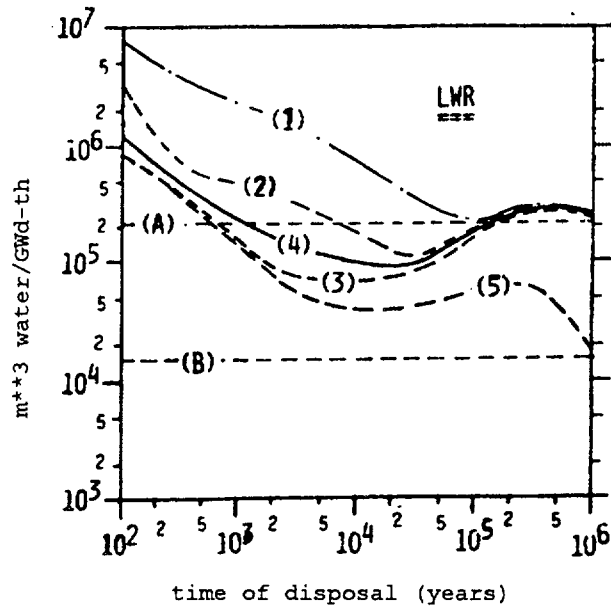

FIG. 3.5.4. Possible limitation of the heavy metal waste toxicity at the U/Pu cycle of the LWR by applying different reprocessing strategies.

3.5.2.2. Nuclear fuel cycle studies

In the IAEA expert report, A Fresh Look at the Thorium Cycle (IAEA 13.30), evaluations and comparisons of the fuel consumption of different fuel cycles, and different reactor types, or reactor operation strategies were made. In principle, the conclusions reached in that report are still valid however, the following more recent evaluations and strategy considerations must be added:

- optimum Pu-burnup (recycle option and one-through mode),
- minimization of highly radioactive waste produced, including actinides,
- more proliferation-resistant fuel cycles,
- breeding of fissile material from Th in accelerators, fusion hybrid breeders or reactors,
- short term application of Th in existing reactors (possibly combined with burning Pu), and
- long term application of Th in advanced reactors (possibly combined with burning Pu).

3.5.2.3. Safety aspects

It is well known that the use of Th-based fuel in reactors can result in differences in the design or safety features. Typical differences are [3.5/3; 3.5/4; 3.5/6; 3.5/7; 3.5/8]:

- significantly lower production of highly-radioactive waste including actinides during reactor operation but some increase in radioactivity after 10^4 to 10^6 years, compared to the end of reactor operation, if specific reprocessing strategies are not followed,
- higher short term decay heat levels (~20–25 per cent), and
- a slight decrease of reactivity coefficients (with no noteworthy effect on safety).

Nevertheless, the consensus of experts in universities, research centers and industry is that Th-based fuel can be used in existing PWRs without significant effect on overall safety. The burnup of Pu in pure Th-cycles (no uranium added) is at least a factor of 3 higher than the burnup in a U-cycle (where new Pu is produced). However, the reactivity coefficients, especially in LWR-systems, are somewhat smaller if adequate design measures are not taken.

3.5.3. India

3.5.3.1. Nuclear data

Nuclear data for the thorium chain are available in basic data libraries such as ENDF/B and JENDL, and also in the form of processed data libraries used in codes like WIMS or HAMMER. However, since the thorium cycle was never as intensely studied and reviewed as uranium, the reliability of these data is not at the same level as the uranium cycle. Another problem with the nuclear data occurs because improved versions of basic libraries, e.g. ENDF/B-IV, ENDF/B-V, ENDF/B-VI, are periodically issued through on-going programs however, these improvements are not always translated into multi-group cross-section libraries.

Benchmark calculations for thorium and ^{233}U lattices have been performed in many countries, including India. These are largely based on cold clean experiments conducted mainly for measurements of material buckling. Notable in this set are experiments at AECL, and Brookhaven National Laboratory, the only ones available using ^{233}U .

Reasonably good agreement is generally obtained when these lattices are analyzed using the present day reactor physics codes (like WIMS) and cross-section libraries. However, adequacy of the data and formalisms for burnup calculations is less well established.

For nuclear data, there is a need to compile available measurements with thorium lattices, including measurements of burnup and the isotopic composition of irradiated thorium where available and to analyze them to evaluate inadequacies from the viewpoint of power

reactor calculations. There should also be an update of multi-group cross-section libraries so reactor calculations can use the latest basic cross-section data.

To go one step further, all present day multi-group cross-section sets use a group structure optimized for the uranium cycle. Thus, group boundaries are positioned so the resonances of uranium 238 are close to the midpoints of the energy groups and care has been taken to see that no resonance straddles two groups. Using the same group structure for thorium could have some of these undesirable results. Some effort should be made to see that the present group structures have no serious shortcomings when used for thorium resonances. Where a resonance appears very close to a group boundary, the group structure in that region can be changed to eliminate the problem. In general, cross-section processing is laborious, and requires powerful computers with large data storage. However, it is possible to work on small regions of multigroup sets with specially written small codes.

3.5.3.2. Nuclear core design

Most of the work performed in the world on nuclear core design using thorium fuel cycles has used reactors designed with uranium cycles in mind. Thorium cycles have been studied, as retrofitted cycles however, there are some designs specifically for thorium. Notable among these are the THTR of Germany a high temperature gas cooled graphite reactor; the Shippingport reactor of USA, a seed and blanket type PWR; and the molten salt breeder reactor (MSBR). The MSBR reactor is not yet a proven reactor, but its physics core design is as good as proven. Work is currently in progress on the advanced heavy water reactor (AHWR) of India, also designed with thorium cycles in mind.

Although India is working on a design specific for thorium, in today's climate it is preferable to design cores for existing reactor types, either by retrofitting thorium cycles or by examining new plants of existing types in which minimal change can be incorporated. For example, coolant flow distributions can be tailored to an equilibrium thorium cycle in which the power distribution differs from an equilibrium uranium cycle.

One variation of the PWR suitable for thorium fuel, is the spectral shift-controlled reactor (SSCR). The absence of control rods in the core during normal operation and the absence of burnable poisons, make the power distribution analysis much simpler. If the uranium fuel in this system is replaced by thorium with some fissile content, it is possible to achieve long cycle times with manageable power distributions.

The seed and blanket design has been demonstrated in the Shippingport core. The goal of obtaining a conversion ratio exceeding unity was achieved there. However, the thorium cycle in the seed and blanket core can be designed in many ways depending upon demand. The design can maximize fuel utilization, or total extractable power from the core, or cycle time for seed replacement, or cycle time for blanket replacement, or any number of other things.

Normal PWR and BWR core design can also be optimized for the thorium cycle so the same core can be operated at higher power levels or longer cycle times. Higher power levels mean changes in turbines and other auxiliaries, i.e., it becomes a relatively major change. The main attraction of the thorium cycle is the possibility of longer cycle times. A design with a longer cycle time for these reactors is unavailable only because no one has worked at it.

A long cycle time has been quoted for the THTR, where the first core was optimized for the thorium cycle. The fuel of micro-particles of thorium- ^{235}U in a graphite matrix was calculated to have a discharge burnup of 100 000 MWd/t. The fissile component was 93 per cent ^{235}U in the Th for the 1st phase, and 10 per cent ^{235}U in the second. The cycle time of each fuel ball was to have been 10 years, but refueling was continuous. Core design of other solid fuel reactors, like heavy water reactors follow a similar pattern, staying close to existing designs.

3.5.3.3. Nuclear fuel cycle studies regarding fuel consumption

Most attractive from the viewpoint of fuel consumption are the fluid fuel reactors, the MSBR and the aqueous homogeneous reactor. The concept rests on the potential for continuous removal of nuclides responsible for parasitic absorption. Efficiency of fuel utilization depends upon the efficiency of removal of the fission products. Assuming zero retention for the fission products, high efficiency and high breeding is gained; as retention increases, the doubling time increases.

Another technique used by circulating fuel reactors is to store the fuel outside the core for some time so that ^{233}Pa decays to ^{233}U in a neutron free environment. In the ideal situation, 100 per cent storage is clearly unachievable. For shorter storage times, a part of the ^{233}Pa is converted into ^{234}Pa by neutron absorption and then β decays to ^{234}U and is thus lost for fuel utilization. As the storage time decreases, breeding gains and doubling time increases.

Next to circulating fuel systems, the best fuel utilization is found in pressurized heavy water reactors and parasitic absorption is lowest in this system. It is possible to design self-sustaining equilibrium thorium (SSET) cycles in this system; when the first charge of ^{233}U is obtained, the reactor continues to produce its own ^{233}U . This results in low burnups but adding a small quantity of makeup fissile material to the thorium- ^{233}U fuel can increase burnup. When no fissile makeup is added, the discharge burnup is low but fuel utilization is 100 per cent. When makeup is added, there is an inverse relationship between the discharge burnup and energy extracted per kg of added fissile material.

High burnup cycles without reprocessing work by adding a fissile component to thorium in the initial fuel. When the initial enrichment is very low, the discharge burnup is low, and the energy extracted per kg of fissile material is also low. As enrichment increases, both these quantities increase, but while the discharge burnup goes on increasing, the energy per kg fissile reaches a maximum and then decreases. This maximum is obviously the optimum point, and in the pressurized heavy water reactor, is at fairly high burnups, exceeding 40 000 MWd/t.

3.5.3.4. Safety aspects

Operationally, thorium is regarded as a better fuel than uranium. The integrity of the fuel matrix is better, thermal conductivity is higher, and the melting point is higher. Thus the probability of fuel melting and the chance of fission gas release is less. The kinetic behavior of thorium fuels must take into account that the delayed neutron fraction (β_{eff}) of ^{233}U is 0.266 per cent, whereas β_{eff} for ^{235}U is 0.65 per cent. Thus the uranium cycle has a relatively more benign behavior than the thorium, at least in the beginning of the cycle. Later ^{239}Pu , which has a β_{eff} of 0.21 per cent builds up and the average delayed neutron fraction decreases.

It may be noted that if the thorium is initially enriched by ^{235}U , which would often be the case, the thorium cycle has a better delayed neutron fraction than a similar enriched uranium fuel, since the nuclide produced is ^{233}U , which has a better β_{eff} than ^{239}Pu . However, if Pu enrichment is used, then the uranium cycle has the advantage of having a certain amount of ^{235}U with its higher delayed neutron fraction, at least at the beginning.

A smaller proportion of long lived actinides produced in the thorium cycle contributes to the safety of the long term disposal of wastes. U-233, which is reprocessed and extracted, is contaminated with ^{232}U , which has a long chain of decay products. Some of these are hard gamma emitters and fabrication of ^{233}U - bearing fuel must be done by remote handling or in shielded glove boxes. These aspects also need consideration during the loading of ^{233}U fuel.

Thorium itself is a gamma emitter and though these are not hard gamma, they still produce exposure greater than that from uranium fuel. Handling of thorium fuel, even in the unirradiated state, thus results in manrem expenditure.

3.5.4. Japan

3.5.4.1. Nuclear data

3.5.4.1.1. Nuclear data for thorium cycle development

Revision of thorium-related data in JENDL-3.2

After the release of revision-1 of the Japanese Evaluated Nuclear Data Library, Version 3 (JENDL-3.1) in 1990, benchmark tests were made for thermal, fast and fusion reactors as well as for shielding experiments. Based on information from these tests, several important reactions and nuclides were re-evaluated. The revision of nuclear data relevant to thorium utilization has been checked.

Resonance parameters of ^{233}U

A new evaluation for resonance parameters of ^{233}U was done by Derrien using the analysis code SAMMY [3.5/10]. Table 3.5.1 compares the results of recent evaluations of the resolved resonance parameters.

Inelastic scattering cross section of ^{233}U

From these results, it was concluded that the inelastic scattering cross section of ^{233}U was too large, and a recalculation was made to better reproduce the experimental data of Smith *et al.* [3.5/11], corrected for missing partial inelastic scattering components in low-lying excited levels. The calculation was made using the generalized transmission coefficients from coupled-channel theory, in combination with the Hauser-Feshbach model. This resulted in values lower than the evaluation of JENDL-3.1.

Fission neutron spectrum of ^{233}U

Evaluation of the fission neutron spectrum of ^{233}U for JENDL-3.1 was based on a calculation using the constant-inverse-cross-section version of the Madland-Nix model [3.5/12] with the level density parameter given by $a=A/11$, where A is the mass number. From the benchmark analysis, it became evident that the spectrum was too hard. A new calculation was attempted by adopting a larger value, $a=A/9$, for the level density parameter. This resulted in a softer spectrum than the JENDL-3.1 evaluation, but later, it was found that the

new spectrum still did not provide good results for the effective multiplication factor, k_{eff} , for ^{233}U -fueled cores [3.5/13].

Benchmark testing of thorium cycle data in JENDL-3.2

Comprehensive benchmark calculations were undertaken using JENDL-3.2 data and comparing them with the results of integral experiments. It was found that satisfactory results were obtained for ^{235}U and Pu-fueled cores however, for ^{233}U -fueled cores, the calculation overestimated k_{eff} for both the JEZEBEL-23 and FLATTOP-23 cores. This motivated further examination of the fission neutron spectrum for ^{233}U .

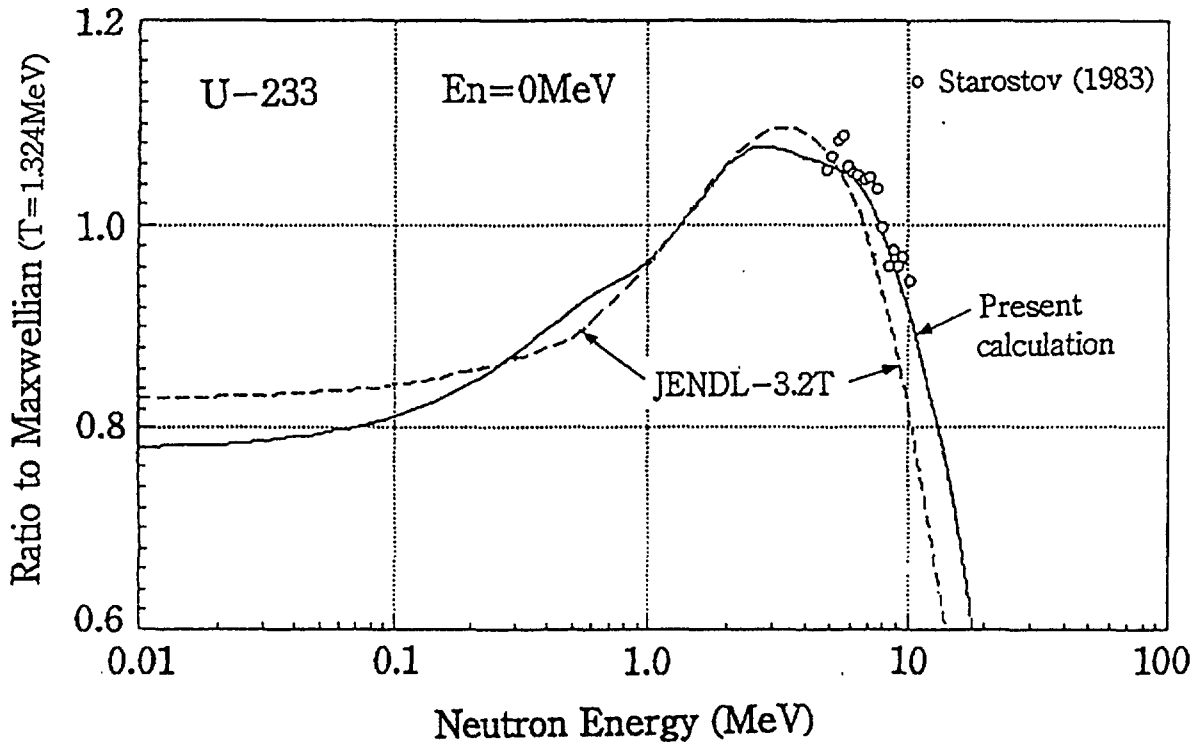

FIG. 3.5.5. Comparison of fission neutron spectra for $\text{U}^{233} (n_{\text{th}}, f)$ calculated by the author/contributor and previous evaluation (labelled as JENDL 3.2T). Note that the spectra are represented as the ratio to Maxwellian distribution with the temperature $T = 1.324 \text{ MeV}$.

An improved method of evaluation of fission neutron spectrum

The author/contributor of this section proposed a new method for evaluation of the fission neutron spectra, taking into account the shell effects on the level density parameter and possible differences in nuclear temperatures of two fission fragments [3.5/14]. The effects of energy dependence of the inverse cross sections and of the multiple-chance fission were also considered in the calculation. Results of an evaluation based on this method for thermal-neutron induced fission of ^{233}U is shown in Figure 3.5.5 and compared with the previous evaluation. It can be seen that the present evaluation is in better agreement with the data of Starostov [3.5/15] and it was found that this evaluation improved agreement with integral data.

3.5.4.1.2. Critical experiments and analyses of thorium contained assembly

Research on the characteristics of thorium reactors was one of the main reasons for constructing the Kyoto University Critical Assembly (KUCA). Three series of experiments have been performed on thorium fueled cores since its first criticality in 1973. The first series was on assemblies with mixed thorium-graphite test regions separated from fuel regions

TABLE 3.5.1. RESONANCE PARAMETERS OF ^{233}U

	JENDL-3.1	JENDL-3.2	ENDF/B-VI
Formula	SLBW ^{a)}	Reich-Moore	Adler-Adler
Region	0–100 eV	0–150 eV	0.79–60 eV
No. of res.	159	189	83

^{a)} SLBW: Single-Level Breit-Wigner

containing thorium only. The second series of experiments were polyethylene moderated cores fueled with mixed thorium and enriched uranium (Th-EU). The third series of experiments were based on molten salt reactor materials.

Some results from the second series of experiments are presented in Table 3.5.2 and examples of core arrangements are shown in Figure 3.5.6. The core assemblies were prepared in plate form with a 2" square cross section. The fuel materials were 93 per cent enriched uranium in aluminum plate 1/16" thick, and 1/8" thick Th plates, combined with 1/4" and 1/8" thick polyethylene plates. Polyethylene was also used for the axial and radial reflectors. The loading patterns for these elements are shown in Figure 3.5.7.

Measurements were made of the effective multiplication factor, the control rod worth, flux distribution, sample worths, and cadmium ratios for various materials. Results were compared to evaluations using collision probability methods for cell calculations and 2-D diffusion theory for whole core analysis.

TABLE 3.5.2. EFFECTIVE MULTIPLICATION FACTORS OF MIXED-TH-EU POLYETHYLENE MODERATED CORES

CORE NAME	EXPERIMENT	CALCULATION	C/E
B3/8"p48Eu16TH(3)	1.01426 ± 0.00031	1.01527	1.00100
B3/8"p48Eu16Th(3)-V4	1.01230 ± 0.00030	1.01680	1.00445
B3/8"p45Eu18Th(3)	1.01203 ± 0.00030	1.01448	1.00243
B3/8"p45Eu18Th(3)-V1	1.01368 ± 0.00029	1.01994	1.00617
B3/8"p36Eu(3)	1.01505 ± 0.00031	1.01654	1.00146
B4/8"p24Eu-Th-Eu(5)	1.00945 ± 0.00029	1.02025	1.01070

The experimental and calculated multiplication factors are shown in Table 3.5.2. The good agreement, to within 1 per cent, is shown in the table. Figure 3.5.8 shows an example of the horizontal Au activation distribution. This figure also shows the good agreement between measured and calculated results. The measured cadmium ratios are shown in Table 3.5.3 and compared to calculated values.

In the thorium molten-salt reactor, LiF-BeF₂-ThF₄-²³³U is used as fuel. The reactivity worth of the molten-salt materials was measured using chemically alternate samples. These samples were beryllium metal (Be), natural LiF, teflon (CF₂)_n, (²³³U)₃O₈-Al, etc [3.5/17].

3.5.4.2. Nuclear core design

Actinide production analysis for Th²³³U fueled LWR

Cell calculations of a Th-fueled LWR were conducted for the burnup period of either 30 or 60 GWd/t to determine the minor actinide (Pa, Np, Am, Cm, etc) quantities in the spent fuel [3.5/18]. Cell calculations were carried out by the SRAC code system [3.5/19] using the ENDF/B-IV cross section library, and burnup calculations using ORIGEN-2 [3.5/20].

TABLE 3.5.3. RESULT OF CADMIUM RATIO EXPERIMENTS

B4/8" P24Eu-Th-Eu(5)				
	Experiment	Error %	Calculation	C/E
DU	1.07	1.33	1.159	1.08
Th	1.63	2.34	1.771	1.09
Au	1.79	0.392	1.956	1.09
W	2.42	0.984	2.414	1.00
In	2.79	1.23	2.804	1.01
Mn	7.81	0.912	7.853	1.01
Eu	0.56	1.07	12.89	1.22
Dy	42.26	0.904	50.86	1.20

Four combinations of fissile and fertile materials were investigated: ²³⁵U + ²³⁸U, ²³³U + ²³⁸U, ²³⁵U + Th and ²³³U + Th. As shown in Table 3.5.4 the minor actinides produced are very small for the ²³³U+Th combination, i.e., 1/7 and 1/14, compared to 30 and 60 GWd/t for the ²³⁵U + ²³⁸U combination, respectively. Increases of the minor actinides produced from 30 to 60 GWd/t is 40 per cent for the ²³³U+Th combination fuel, while it is above 160 per cent for the other combination of fuel. This is because only light actinides are used in ²³³U + Th fuel, so many neutron capture reactions are needed to transmute ²³³U and Th to Np, Am, Cm, etc. From the viewpoint of lower production of minor actinides, the ²³³U/Th cycle LWR has distinct advantages over the ²³⁵U/²³⁸U cycle for LWRs.

Experiments on thorium molten-salt reactor materials

3.5.4.3. Nuclear fuel cycle studies, regarding fuel consumption

Intensive studies were performed on fuel cycles in future equilibrium nuclear energy systems [3.5/21 to 3.5/23] to compare the thorium cycle with the uranium-plutonium cycle. A complete nuclear energy center is envisioned to confine radioactive materials from the

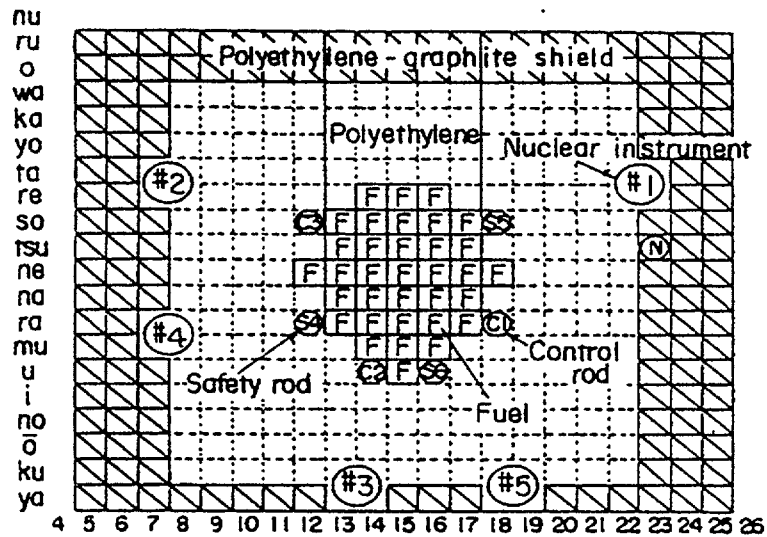

B3/8"p48EU16Th(3)-V4

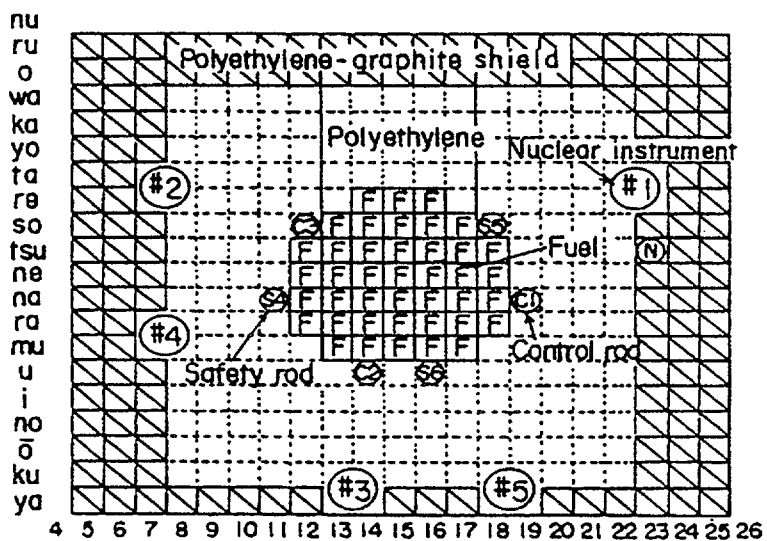

B3/8"p45EU18Th(3)-V1

FIG. 3.5.6. Core configurations.

environment. Natural uranium or thorium is inserted into the reactors in the center as part of a continuous process. All of the actinides are recycled into the reactor.

The end products of the heavy isotope decay series (lead and bismuth) and the stable fission products are removed from the center. The discharged short-life fission products and ^{90}Sr , ^{137}Cs and ^{151}Sm are also allowed to decay in the nuclear center. Two types (hard-spectrum and soft-spectrum) of each thermal reactors and fast reactors were considered. Design parameters are shown in Table 3.5.5, as typical examples for the study. These designs correspond to the following reactors:

- hard-spectrum fast reactor = sodium-cooled metal-fuel reactor;
- soft-spectrum fast reactor = sodium-cooled oxide-fuel fast reactor;
- hard-spectrum thermal reactor = PWR with recycled Pu; and
- soft-spectrum thermal reactor = homogeneous graphite moderated reactor with C/U ratio of about 10^4 .

$B^{3/8}p48EU16Th(3)$ standard fuel element

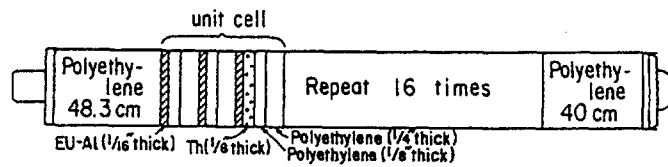

$B^{3/8}p48EU16Th(3)$ V4 fuel element

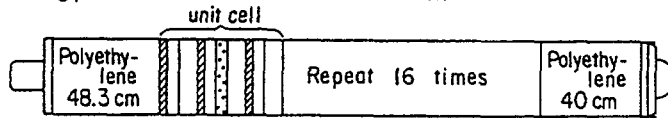

$B^{3/8}p45EU18Th(3)$ standard fuel element

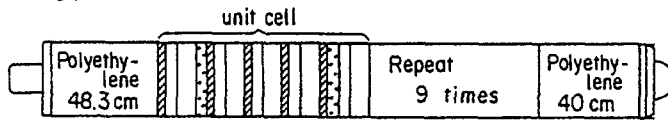

$B^{3/8}p45EU18Th(3)$ VI fuel element

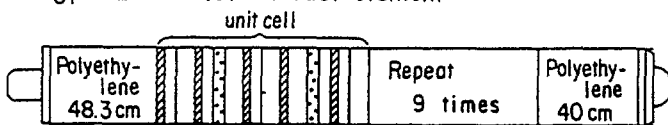

FIG. 3.5.7. Loading patterns of fuel elements.

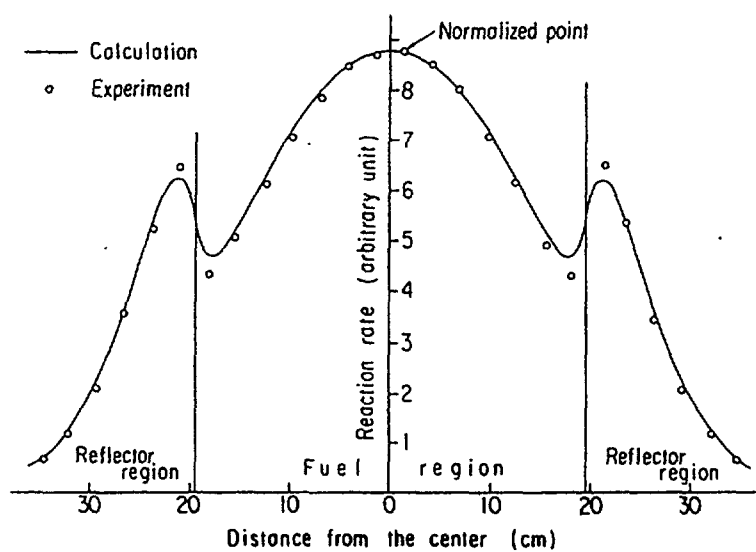

FIG. 3.5.8. Au activation distribution of $B^{3/8}p45EU18Th(3)$ -VI core.

TABLE 3.5.4. ACTINIDE PRODUCTION DURING BURNUP IN A ONCE THROUGH CYCLE

		30 Gw d/t		60 Gw d/t	
		$^{235}\text{U} + ^{238}\text{U}$	$^{233}\text{U} + \text{Th}$	$^{235}\text{U} + ^{238}\text{U}$	$^{233}\text{U} + \text{Th}$
Fuel	Th	2.1×10^{-4}	$-3.0 \times 10^4 **$	7.3×10^{-4}	$-5.2 \times 10^4 **$
	U	$-4.1 \times 10^4 **$	$-1.5 \times 10^3 **$	$-7.5 \times 10^4 **$	$-9.9 \times 10^3 **$
	Pu	9.2×10^3	4.1×10^{-1}	1.2×10^4	8.9×10^0
	Total	$-3.1 \times 10^4 **$	$-3.1 \times 10^4 **$	$-6.3 \times 10^4 **$	$-6.2 \times 10^4 **$
Minor actinide	Pa	3.0×10^{-5}	7.6×10^1	5.3×10^{-5}	8.4×10^1
	Np	3.6×10^2	2.4×10^0	9.0×10^2	2.7×10^1
	Am	1.6×10^2	1.0×10^{-4}	4.7×10^2	8.5×10^{-3}
	Cm	3.6×10^1	6.0×10^{-6}	2.2×10^2	1.4×10^{-3}
	Total	5.6×10^2	$7.9 \times 10^1 (1/7)*$	1.6×10^3	$1.1 \times 10^2 (1/14)*$

* compared to that of $^{235}\text{U} + ^{238}\text{U}$ combination.

** negative sign means destruction [3.5/18 to 3.5/20].

The number density for each nuclide in the equilibrium state was evaluated as shown in Table 3.5.5 [3.5/23] for nuclei with densities greater than 10^{18}cm^{-3} . The actinide nuclides existing in the uranium cycle are heavier than those in the thorium cycle. The amount of heavier nuclides increases for the softer spectrum and higher flux level, and vice versa.

The following quantity is defined as the h-value:

$$h = \frac{\nu \sum_f}{\sum_a} = \frac{(\nu \sigma_f / n)}{\nu_a / n}$$

where the elements of vector n are nuclide densities for both heavy nuclides generated from inserted fuel and fission products in the reactor. It is similar to the h-value but includes the fission product contribution. Then it is similar to the infinite neutron multiplication factor, but does not include the contribution from coolant, construction materials and others in the core. To make the reactor critical

$$h > 1.$$

Figure 3.5-9 (a and b) shows the calculated h-values. The nuclide densities change with the neutron flux level since the branching ratio is changed. Then the h-value also changes with the flux level. As for the uranium cycle, if both thermal reactors show h-values less than unity, then thermal reactors with natural uranium are unable to reach an equilibrium state. However, the values for both fast reactors exceed unity (Figure 3.5.9a). The hard-spectrum fast reactor in particular shows a large h-value (about 1.3), and may easily attain the equilibrium state by employing proper reactor design and fuel management. As for the thorium cycle, all the reactors are able to achieve h-values greater than unity but only by a small amount (Figure. 3.5.9b). Thus it may be difficult to achieve the equilibrium state only with the thorium cycle.

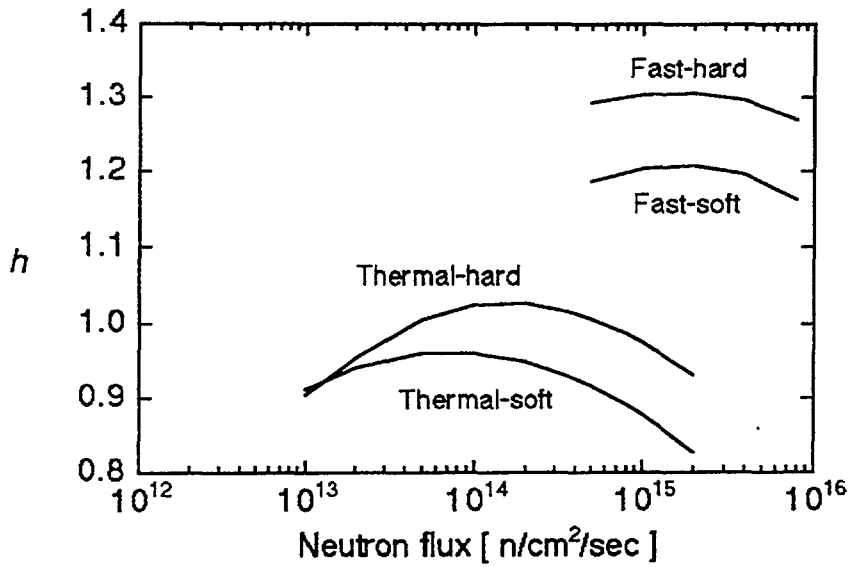

FIG. 3.5.9a. H values in dependence of the neutron flux level for different reactors and fuels in the equilibrium nuclear state (natural uranium fed).

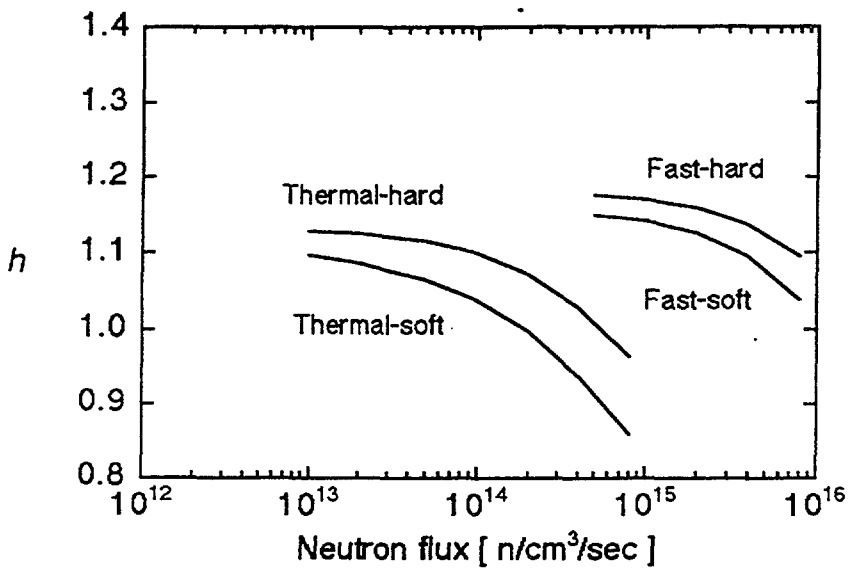

FIG. 3.5.9b. H values in dependence of the neutron flux level for different reactors and fuels in the equilibrium nuclear state (thorium fed).

TABLE 3.5.5. REACTOR DESIGN PARAMETERS

	Thermal reactors	Fast reactors
Thermal power output	3 GW(th)	3 GW(th)
Power density	50 W/cm ³	300 W/cm ³
Discharge constant*	0.347 a ⁻¹	0.347 a ⁻¹

* Discharge rate for reprocessing

TABLE 3.5.6. ACTINIDE ATOMIC DENSITIES FOR DIFFERENT REACTORS AND FUEL^a

Reactor Spectrum	Uranium feed				Thorium feed			
	Fast reactor		Thermal reactor		Fast reactor		Thermal reactor	
	Hard	Soft	Hard	Soft	Hard	Soft	Hard	Soft
Th 232	3.12-E+13	1.72E-13	2.16E-12	7.40E+11	1.47E+22	1.01E+22	2.35E+22	1.56E+22
Pa 231	2.11E+14	1.36E+14	2.53E+12	8.28E+10	1.42E+19	7.51E+18	2.61E+18	8.08E+16
233	6.31E+11	4.09E+11	5.97E+10	8.63E+09	3.04E+19	3.06E+19	4.64E+18	5.06E+18
U 232	1.36E+14	1.09E+14	5.25E+12	1.55E+11	8.59E+18	5.72E+18	5.37E+18	1.51E+17
233	1.61E+15	1.13E+15	1.15E+13	1.13E+11	1.61E+21	1.37E+21	1.19E+20	4.34E+19
234	8.40E+18	6.94E+18	2.90E+17	1.90E+16	5.52E+20	4.72E+20	3.97E+19	2.01E+19
235	1.75E+19	1.39E+19	1.46E+18	3.60E+17	1.07E+20	1.06E+20	1.86E+19	5.14E+18
236	2.21E+19	1.74E+19	1.45E+18	7.99E+17	1.13E+20	1.13E+20	1.80E+19	1.13E+19
238	1.49E+22	1.02E+22	8.61E+21	7.37E+21	8.64E+16	1.51E+17	1.23E+17	2.87E+17
Np 237	1.65E+19	1.04E+19	1.63E+18	1.84E+17	2.49E+19	2.72E+19	5.06E+18	1.95E+18
239	2.42E+18	2.50E+18	3.95E+17	4.44E+17	1.49E+13	3.96E+13	6.35E+13	1.95E+14
Pu 238	4.85E+19	5.08E+19	5.01E+18	3.39E+17	1.98E+19	2.62E+19	5.52E+18	1.06E+18
239	1.91E+21	1.61E+21	4.95E+19	1.95E+19	5.30E+18	8.50E+18	1.09E+18	3.47E+17
240	9.77E+20	1.03E+21	1.71E+19	7.57E+18	2.69E+18	5.42E+18	3.77E+17	1.34E+17
241	1.39E+20	1.84E+20	1.87E+19	6.02E+18	3.82E+17	9.68E+17	4.12E+17	1.07E+17
242	1.10E+20	1.49E+20	2.15E+19	1.59E+19	3.02E+17	7.84E+17	4.73E+17	2.81E+17
Am 241	5.85E+19	5.72E+19	1.50E+18	1.91E+17	1.61E+17	3.00E+17	3.30E+16	3.39E+15
242m	2.83E+18	3.26E+18	2.37E+16	2.17E+15	7.78E+15	1.71E+16	5.22E+14	3.83E+13
243	2.99E+19	4.29E+19	1.23E+19	8.11E+18	8.24E+16	2.25E+17	2.70E+17	1.44E+17
Cm 242	2.56E+18	3.52E+18	4.09E+17	1.27E+17	7.06E+15	1.85E+16	8.99E+15	2.25E+15
244	2.55E+19	4.41E+19	2.49E+19	1.99E+19	7.02E+16	2.32E+17	5.48E+17	3.52E+17
245	5.44E+18	1.13E+19	3.65E+18	9.62E+17	1.50E+16	5.91E+16	8.03E+16	1.70E+16
246	3.18E+18	6.53E+18	1.45E+19	1.59E+19	8.75E+15	3.43E+16	3.19E+17	2.82E+17
247	3.44E+17	9.23E+17	1.37E+18	9.40E+17	9.48E+14	4.85E+15	3.01E+16	1.67E+16
248	3.05E+17	7.83E+17	3.10E+18	3.53E+18	8.39E+14	4.11E+15	6.83E+16	6.24E+16

^a Only nuclei with densities greater than 10^{18}cm^{-3} are listed in this figure, though 75 heavy nuclides were considered in this study.

Fission product waste disposal is a problem for the nuclear energy center that becomes more severe with time [3.5/24]. In our present system, the middle-lived fission products (⁹⁰Sr, ¹³⁷Cs and ¹⁵¹Sm) are stored in a repository in the center. The equilibrium amount of each nuclide stored in the repository is about 1 t per 3-GW(th) reactor [3.5/25]. Even if isotope separation is not used, and their stable isotopes included, the stored quantity increases by only a few orders of magnitude, and the total still remains manageable. The long lived fission products (⁷⁹Se, ¹²⁶Sn, ⁹⁹Tc, ⁹³Zr, ¹³⁵Cs, ¹⁰⁷Pd and ¹²⁹I), are also stored in the repository, and accumulate. They may be incinerated in the reactor [3.5/25], but isotope separation is required, otherwise the reactor becomes sub-critical. However the toxicity of long lived fission products is not as high as for the other waste products.

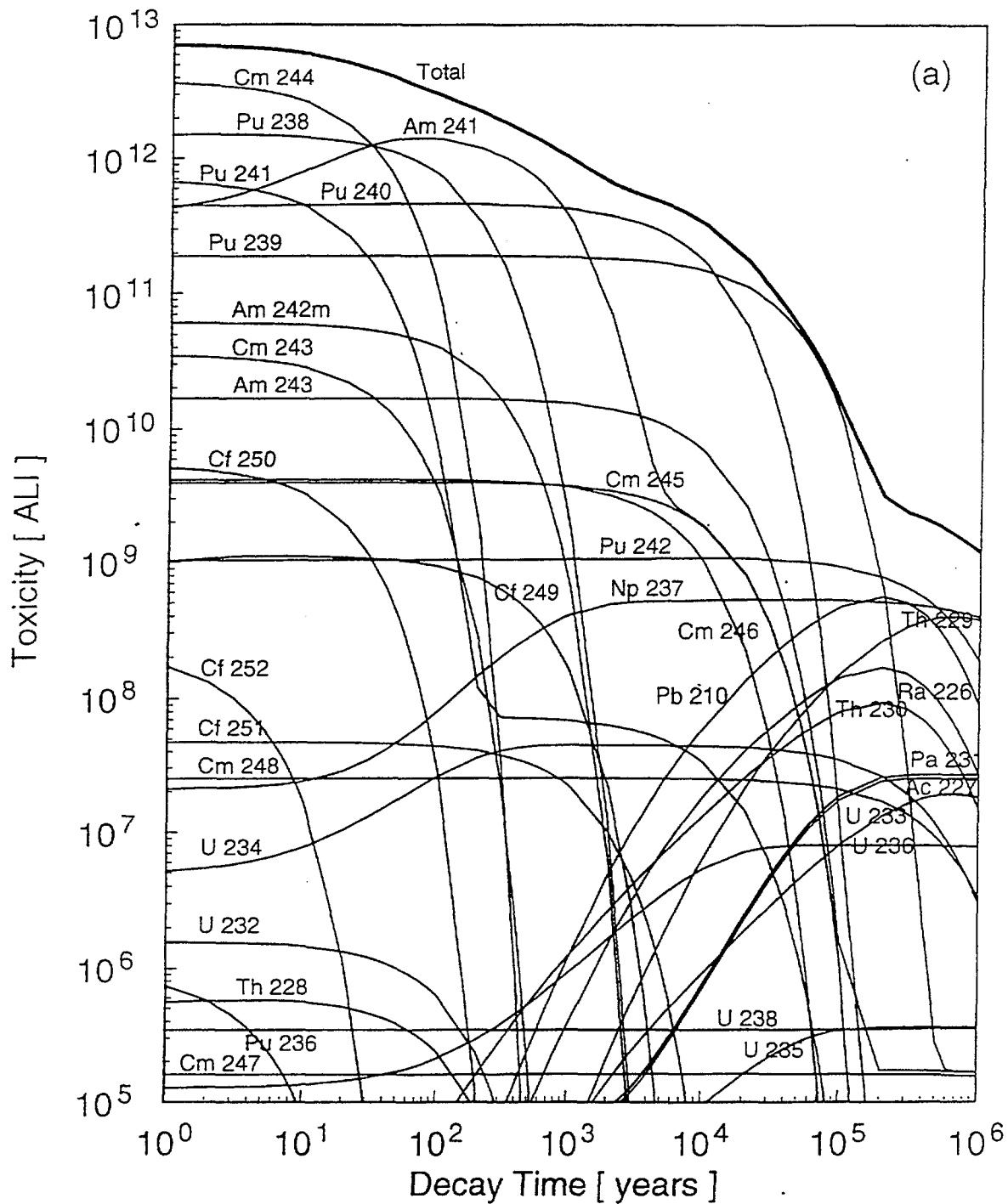

FIG. 3.5.10a. Toxicities expressed in ALI of whole amounts of actinides reprocessed per year for (a) the soft-spectrum fast reactor fed with natural uranium. The abscissa is the time after they are removed from the reactor.

The risk factor may be the best criteria for evaluating this problem but it depends on the disposal method and environmental conditions. Moreover, there are large uncertainties in any analysis of this problem. However, the toxicity per unit radioactivity is given for most nuclides and it can be used like nuclear data. There are several kinds of toxicity units so there is some ambiguity in the choice. For the present discussion, the annual limit on intake (ALI) is employed [3.5/26] and the possibility of fission nuclear systems which satisfy the condition that the toxicity of waste discharged from the nuclear energy center is lower than the toxicity of the fuel loaded into the reactor is evaluated.

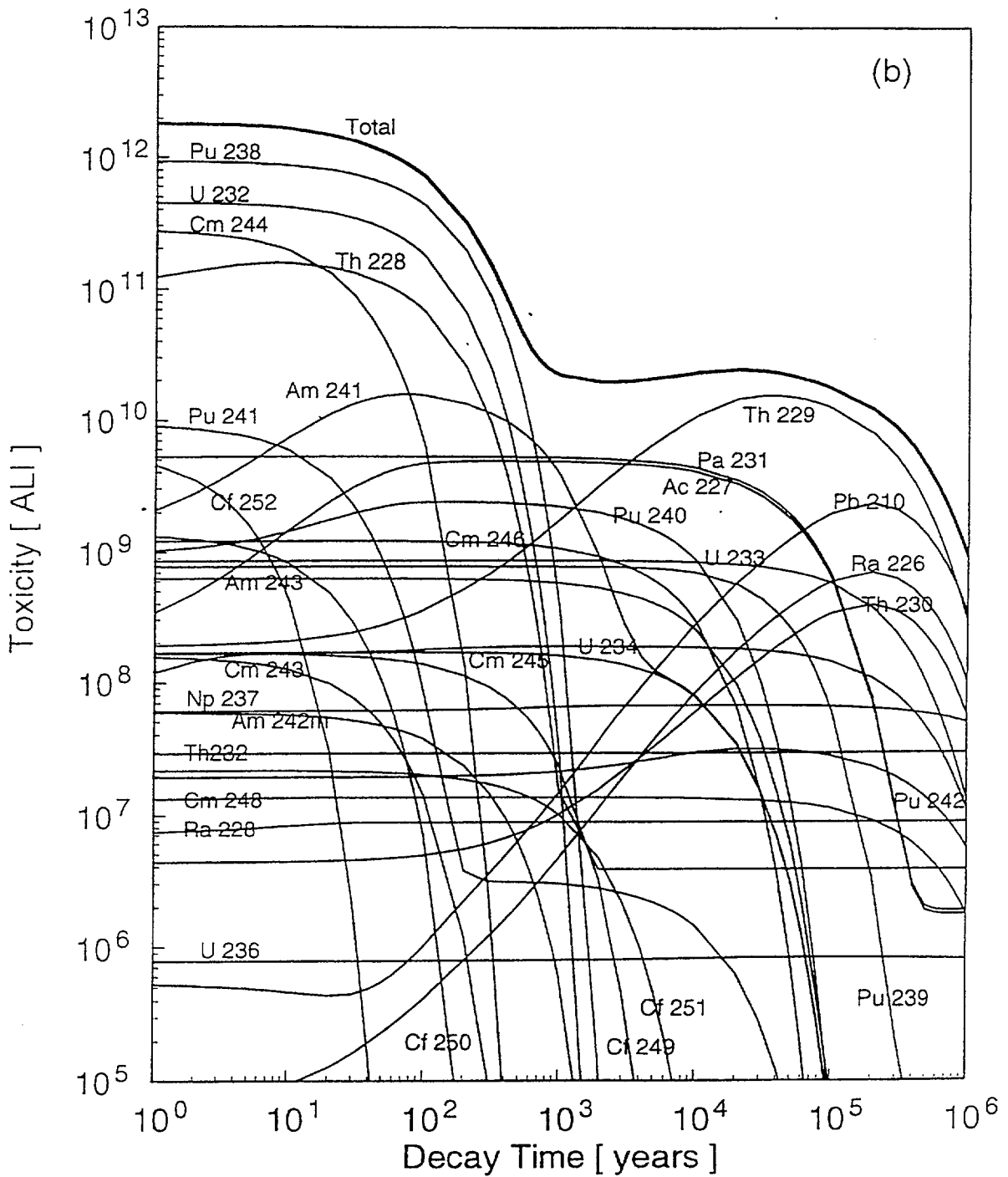

FIG. 3.5.10b. Toxicities expressed in ALI of whole amounts of actinides reprocessed per year for (b) the hard-spectrum thermal reactor with thorium. The abscissa is the time after they are removed from the reactor.

A fuel load of about 1.1 t natural uranium or thorium is charged into a 3 GW(th) reactor in our system. The long lived daughters of natural uranium or thorium can be included with only negligible change to the neutron multiplication factor. The toxicity level of 1.1 t of uranium fuel reaches the equilibrium value of 1.1×10^6 ALI at $\sim 3 \times 10^5$ years for pure natural uranium, at ~ 6000 years if the daughters of thorium are included, and at ~ 70 years when both the daughters of thorium and radium are present. On the other hand, the toxicity of thorium reaches its equilibrium value of 2.6×10^5 ALI quickly (within 20 years) without daughters present.

A 3 GW(th) reactor consumes about 1.1 t of fuel, and then produces fission products of about 1.1 t. About 11 per cent of them are long lived fission products. Their toxicities are shown in Table 3.5.7. With a few exceptions (^{107}Pd , ^{135}Cs), they are not very sensitive to either reactor type or type of inserted fuel, and remain constant for almost 10^5 years. These values are close to the incinerated toxicities, a little bit lower than the equilibrium uranium toxicity and about one third of the equilibrium thorium toxicity.

All actinides are recycled into the reactor and confined in the system however it is impossible to confine them perfectly and a small part may leak into the biosphere. The most probable mechanism for leakage may be during the reprocessing step where fission product contaminants may be discharged into the environment. The toxicity of actinides after reprocessing depends primarily on the fed fuel, and only slightly on the reactor type. It changes with time after discharge from the reactor, as shown in Figure 3.5.10a and 10b for typical systems. The toxicity of reprocessed actinides from natural uranium is roughly one order of magnitude higher than for thorium. These values should be compared with the incinerated toxicity levels. The leakage rate, for which the toxicity in the environment remains constant, depends on the time after leakage as shown in Table 3.5.8. In this table, the time lag between fuel charge and discharge is neglected.

TABLE 3.5.7. TOXICITIES MEASURES BY ALI OF THE LONG LIVED FISSION PRODUCTS REMOVED ANNUALLY FROM A 3 GW(th) REACTOR

Fuel Reactor Spectrum	Uranium				Thorium			
	Thermal		Fast		Thermal		Fast	
	Hard	Soft	Hard	Soft	Hard	Soft	Hard	Soft
Se-79	4.20E+04	5.11E+04	5.46E+04	5.69E+04	1.12E+05	1.15E+05	1.14E+05	1.17E+05
Zr-93	3.31E+04	3.24E+04	3.36E+04	3.45E+04	5.40E+04	5.33E+04	5.39E+04	5.43E+04
Tc-99	8.79E+04	9.31E+04	9.98E+04	1.02E+05	6.19E+04	6.23E+04	6.84E+04	6.90E+04
Pd-107	2.43E+02	2.30E+02	1.88E+02	1.80E+02	1.11E+01	1.45E+01	1.33E+01	1.27E+01
Sn-126	2.02E+05	2.23E+05	2.32E+05	2.33E+05	2.31E+05	2.10E+05	2.22E+05	2.21E+05
I-129	1.98E+05	2.28E+05	2.35E+05	2.43E+05	2.22E+05	2.39E+05	2.52E+05	2.56E+05
Cs-135	1.31E+04	2.15E+04	5.58E+04	5.68E+04	1.34E+04	2.31E+04	5.90E+04	5.95E+04
Total	5.76E+05	6.49E+05	7.11E+05	7.26E+05	6.94E+05	7.03E+05	7.69E+05	7.77E+05

TABLE 3.5.8. LEAKAGE RATE FOR WHICH THE TOXICITY IN THE ENVIRONMENT REMAINS CONSTANT

Decay time (years)	Discharged fuel from uranium cycle			Discharged fuel from thorium cycle	
	U	U+Th	U+Th+Ra	Th	Th+Ra
10	1.08×10^{-8}	3.02×10^{-8}	9.48×10^{-8}	1.37×10^{-7}	1.53×10^{-7}
100	2.25×10^{-8}	7.24×10^{-8}	3.59×10^{-7}	3.65×10^{-7}	3.66×10^{-7}
1000	7.41×10^{-8}	5.11×10^{-7}	1.12×10^{-6}	1.17×10^{-5}	1.18×10^{-5}

After 10 years of cooling, the acceptable leakage rate for the pure uranium feed is very low ($\sim 10^{-8}$) and about one tenth of the rate for both the uranium + thorium + radium, and the thorium, feed cases. After 100 years of cooling, the acceptable leakage rate is considerably increased to $\sim 4 \times 10^{-7}$ for both uranium + thorium + radium, and thorium, feed cases.

After 1000 years cooling, the acceptable leakage rate is $\sim 10^{-6}$ for the uranium + thorium + radium feed case, and $\sim 10^{-5}$ for the thorium feed case. The 1000 years confinement is about the same as that required for confinement of middle-life fission products (^{90}Sr , ^{137}Cs and ^{151}Sm). Though this period seems too long for human control, it may be an acceptable period for waste confinement by underground artificial barriers, judging from geological studies. Or assuming a future nuclear equilibrium society, waste may be stored in the energy center.

A synergistic fission system of fast and thermal reactors with U and Th mixed fuel cycles is also discussed for the future nuclear equilibrium state [3.5/27]. It is a sustainable self-contained fission system for both fuel production and long lived radioactive waste elimination. The use of Thorium in the synergistic system can save fission resources. Ideally, three fast reactors produce fuel for one thermal reactor and these three fast reactors and the one thermal reactor incinerate the long lived fission products produced in all four. In this way, the long lived fission product inventory is reduced to about 50 per cent compared to a single fast fission system.

3.5.5. Russian Federation

3.5.5.1. Nuclear data

The WIMS-D4 code [3-5/28] with a revised nuclear cross-section data library was used to prepare the group constants for Th fueled thermal reactors. The following nuclear data sets were the sources for the revised nuclear data library, in particular for the main nuclides of the Th fuel cycle (^{232}Th , ^{231}Pa , ^{233}Pa , ^{232}U , ^{233}U):

- FOND-2 — the 2-nd version of the Russian library of evaluated nuclear data
- the basis of BNAB-90 [3.5/29];
- ENDF/B-6 — the latest version of the USA national library of evaluated nuclear data [3.5/30];
- JENDL-3 — the latest version of the Japan national library of evaluated nuclear data [3.5/31];
- JEF-2 — the latest version of European library of evaluated nuclear data.

All four libraries were independently compiled in the same time frame (1989–1992) based on analogous experimental data and in some cases the same evaluations are used. Therefore, data divergence can be explained by disagreement among the evaluators on the specific experimental information to use in the library. To compare the libraries listed above, the cross section data were transformed to a 28-group set of constants, i.e., the BNAB [3.5/32] system standard. The results of the analysis can be summarized as follows:

Thorium-232. The capture cross-section of the most important thermal energy is the same for all libraries. Disagreement in the scattering cross-section is ~ 1 barn, considerably more than the evaluated error for this cross section (~ 0.1 barn). JENDL-3 data seem unusually high. Disagreement on the resonance capture integral (~ 1.5 barn) is lower than the experimental error (~ 3 barn). There is considerable variation in the inelastic cross section data.

The removal cross-section in the energy region below the ^{238}U fission threshold is about 15 per cent lower, according to ENDF/B-6 and JENDL-3, than the value given in

FOND-2 and JEF-2. In the energy range of 0.8-4 MeV, the disagreement is 30–40 per cent. To solve this problem some integral experiment data must be considered. In 1995, at IPPE, some measurements will be done of fission neutron removal in the energy region below the ^{238}U fission threshold, using the method of spherical transmission.

Protactinium-231. Experimental information for ^{231}Pa ($T_{1/2} = 32760$ years) is much sparser than that for thorium. The evaluation is the same at FOND-2, ENDF/B-6 and JEF-2 however; the only independent evaluation is the one for JENDL-3. Thermal cross-sections correspond to recommendations by Mughabhab [3.5/33]. The measurements of the average capture cross-section of ^{231}Pa in the BN-350 reactor neutron spectrum [3.5/34] permit verification of the data used in the evaluations. Calculations have shown that data of the first three libraries greatly exceed the measured value of the capture cross-section and that the JENDL-3 data slightly underestimate the measured value. Agreement with BN-350 experiments can be obtained by increasing the JENDL-3 cross-sections in the unresolved resonance range by about 20 per cent.

Protactinium-233. There are two alternative evaluations for this short-lived isotope ($T_{1/2}=27$ days): ENDF/B-6 (1978) and JENDL-3 (1987). As both evaluations were based on the resonance parameters recommended by Mughabhab [3.5/33], there are no noteworthy differences in the thermal and resonance energy ranges. Because the JENDL-3 data for ^{233}Pa are not only based on calculations, but also on experiments (but indirect) these data were recognized as preferable.

Uranium-232. There is an analogous situation for the constants for ^{232}U as for ^{232}Pa mentioned above. Here the JENDL-3 data are also the basis. At the same time it should be noted that because of the equal sum of capture and fission cross-sections for all evaluations, the reactor characteristics and ^{232}U concentration calculations are essentially independent of the choice of the evaluation.

Uranium-233. There are practically equal evaluations of ^{233}U data at all four libraries. The FOND-2 data were chosen. WIMS-D4 was used later for calculations of thorium fueled thermal reactors.

3.5.5.2. *The core characteristics of th-fueled LWRs*

A set of calculations has been performed to estimate the WWERs and RBMKs characteristics using ^{232}Th fuel.

WWER-type reactors with thorium fuel

Both WWER-1000 and the advanced NP-500 reactors were investigated regarding the use of thorium fuel in LWRs. The parameters of the NP-500 regarding fuel pin lattice, driver and control subassemblies are similar to the corresponding WWER-1000 values, but the thermal power rating is reduced from 3000 MW(th) to 1800 MW(th). The following variants were considered:

NP-500 reactor with (^{233}U) O_2 + ThO_2 -fuel)

Dependence of the conversion coefficient from the $V_f/V_{\text{H}_2\text{O}}$ ratio with the variation of pin lattice pitch to pin diameter for the constant pin lattice pitch was defined. It was shown that the ^{233}U content for a design fuel burnup of 45 MWd/kg decreases from 3.2 per cent with a fuel pin pitch of $h=12.75$ mm, to a minimum at $h=11.64$ mm, and then increases to 3.3 per cent at $h=9.92$ mm. The conversion coefficient changes from 0.74 to 0.95 in this case.

Analogous dependencies were obtained for a fuel pin diameter increase, but the increase of the conversion coefficient is lower than in the first case, which could be explained by the self-shielding of the fuel pin.

Various options for ^{233}U production in the NP-500 reactor were considered. It was shown that for a plutonium-thorium ($\text{PuO}_2\text{-ThO}_2$) fuel inventory with a plutonium ratio of 3.5 per cent, seventy percent of plutonium loaded could be burned with a simultaneous annual ^{233}U production of approximately 170 kg. In this case, the conversion ratio is small, ~ 0.30 per cent, but this cycle is attractive from the point of view of weapon plutonium utilization without further Pu build-up. The reactor control may be the significant problem of this cycle because the use of a plutonium-thorium fuel with high neutron capture in a thermal energy group leads to a decrease in control rod effectiveness. The delayed neutron fraction, β_{eff} decreases to 0.0032.

The cermet fuel pin (oxide fuel in microballs in a zirconium matrix) for LWRs is currently under investigation in Russia. The main advantage of cermet fuel is the significant pin temperature reduction and the accompanying safety enhancement. Therefore some calculations of a NP-500 ($\text{PuO}_2 + \text{ThO}_2 + \text{Zr}$ -fueled) reactor were carried out. The material volume ratios ($\text{PuO}_2/\text{ThO}_2/\text{Zr}$) for these calculation was 3.6/46.4/50 per cent. Some intermediate variants were also considered in which the subassemblies with plutonium-thorium fuel were partly exchanged (from 0 to 100 per cent) for subassemblies with cermet uranium oxide fuel ($\text{UO}_2 + \text{Zr}$), with volume ratios of UO_2/Zr of 60/40 per cent and a ^{235}U enrichment of 4.4 per cent. This approach is needed for a smooth plutonium-thorium fuel insertion in the reference fuel cycle. Calculations show that the fraction of plutonium burnt in cermet type plutonium-thorium subassemblies is 75 per cent and the conversion ratio of plutonium to ^{233}U is reduced to 0.22. The reactor physics parameter change (e.g. β_{eff}) from the portion of plutonium-thorium subassemblies in the reactor core volume is practically linear. The important advantage in the variants with mixed loading is a power density flattening on the boundaries of different types of fuel.

In the ($\text{PuO}_2\text{-ThO}_2\text{-fuel}$) type loading in one third of the WWER-1000 core region, nearly 250 kg of weapons-grade plutonium will be burned annually, and approximately 70 kg of ^{233}U obtained. An attractive feature of this method, described above, is that no radical reshaping of the control rod system is needed.

RBMK-type reactors with uranium-thorium fuel

RBMK-type reactors supply more than 50 per cent of the total nuclear power generated in Russia. Despite major concerns about this reactor type after the Chernobyl accident, it is useful to consider using thorium in the RBMK. It has a rather soft neutron spectrum but a serious disadvantage is the possibility of a positive void reactivity coefficient. Additional control rods inserted in the core avoid this. Because of the higher capture cross section of Th compared to U at thermal energies, the void effect can be reduced or even made negative in a thorium fuel cycle without additional control rods.

Comparative calculations of RBMK reactor characteristics under equilibrium cycle conditions with both the reference fuel (low enriched uranium dioxide) and uranium-thorium fuel ($\text{UO}_2 + \text{ThO}_2$) with highly enriched, or weapons-grade, uranium ($^{235}\text{U} = 95\%$) were conducted. It was shown that the conversion ratio for weapon-grade uranium into ^{233}U in an RBMK is 0.5 and the annual ^{233}U build-up is ~ 400 kg. The void coefficient is reduced by a factor of 2.5 under normal operating conditions. Thus no additional control rods need be inserted to improve the safety of this reactor.

LMR core design

Analytical studies of ^{233}U and Th based fuel cycles were mainly centered on the calculation of the core physics for 800 MW(e) BN type reactors. Plutonium is used as fissile material, while thorium is the fertile material. Core and blanket fuel can be oxide or metal or it can be of the cermet type. In the latter case, PuO_2 or UO_2 oxides are dissolved in the metal thorium matrix. To improve the fast reactor safety characteristics from the beginning, the core can be loaded fully or partially with ^{233}U . This optimizes safety parameters and breeding characteristics.

The results of the 800 MW(e) fast reactor analysis [3.5/35] are shown in Table 3.5.9. It gives the main physical characteristics of the BN type reactors with various fuel compositions under equilibrium conditions.

The results of these studies have been compared with the data from the 800 MW(e) traditional breeder reactor with MOX fuel; and the comparison is summarized below:

The use of PuO_2 -Th fuel in the core and metal Th in the blanket results in:

- no change in the sodium void reactivity effect;
- a slight decrease in the Doppler effect;
- a considerable reduction in the burnup reactivity (about 1.7 per cent during 150 days of full load operation;
- burnup of 500 kg plutonium per reactor year, 600 kg of ^{233}U produced/a; and
- a 0.8% protactinium reactivity effect during the refueling period (20 days).

TABLE 3.5.9. PHYSICAL CHARACTERISTICS OF THE BN-800 TYPE REACTOR WITH VARIOUS FUEL COMPOSITIONS UNDER EQUILIBRIUM CONDITIONS

Core fuel Parameters	UO_2 - PuO_2	ThO_2 - PuO_2	Th- PuO_2	Th- $^{233}\text{UO}_2$	Th- ($^{233}\text{U}+\text{PuO}_2$)
Blanket fuel Options	UO_2 1	ThO_2 2	Th 3	Th 4	Th 5
SVRE _{core} , $\Delta k/k$	3.1	2.6	3.0	-0.3	0.6
SVRE _r , $\Delta k/k$	2.9	2.4	2.9	-1.0	0.2
$K_0 \cdot 10^{-3}$, $-\text{Tdk}/dT$	4.3	3.0	1.7	2.1	1.5
$\beta_{\text{eff}} (10^{-3})$	3.52	2.99	3.03	4.0	3.04
Δk , %	2.7	1.7	1.7	3.5	3.1
BR _{core}	0.69	0.67	0.71	0.54	0.57
BR	1.16	1.15	1.27	1.02	1.07
Gfis, kg	2020	2240	2230	2220	2240
Gax.bl., kg	13300	13300	15000	15000	14600
RPu, kg/a	195	-520	-515	-	-224
$R^{233}\text{U}$, kg/a	-	607	660	12	276
Protactinium effect, % (refueling time = 20 days)	-	0.8	0.8	0.6	0.6

Note: RPu = annual Pu production; $R^{233}\text{U}$ = annual ^{233}U production; Δk = reactivity change during 150 days.

The use of $^{233}\text{UO}_2\text{-ThO}_2$ in the core and metal Th in the blanket results in:

- a negative sodium void reactivity effect (SVRE core = -0.3%, SVREr~ -1%);
- a slight decrease in the Doppler effect;
- increase of the fuel burnup reactivity value (up to 3.5% during 150 days of full load operation);
- an excess plutonium production of 12 kg/a; and
- a slight reduction of the protactinium reactivity effect: 0.6% during 20 days.

The use of $\text{UO}_2\text{-ThO}_2$ fuel in the internal subzone, $\text{PuO}_2\text{-Th}$ fuel in the external subzone and metallic Th fuel in the blanket results in:

- acceptable SVRE values;
- some reduction in the Doppler effect;
- a near traditional change in the value of the fuel burnup reactivity (about 3% during 150 days of full load operation);
- about 230 kg of plutonium burned and about 280 kg of ^{233}U produced annually; and
- a 0.6% protactinium reactivity effect during 20 days.

3.5.5.3. Fuel balance

The specific scenario being considered essentially determines the isotope balance in the fuel cycle. Initially it is important to consider scenarios with the ^{233}U production using other fissile materials, e.g. plutonium and ^{235}U . Table 3.5.10 gives an example of annual charge and discharge values for thorium, uranium and plutonium isotopes. This is for the open fuel cycle of the NP-500 reactor with a full load of plutonium-thorium fuel ($\text{PuO}_2 + \text{ThO}_2$) using weapons grade plutonium and of the RBMK reactor with a full load of uranium-thorium fuel ($\text{UO}_2 + \text{ThO}_2$) using weapons grade uranium.

TABLE 3.5.10. ANNUAL BALANCE OF THORIUM, URANIUM AND PLUTONIUM FOR NP-500 AND REACTORS WITH FUEL LOADING OF PLUTONIUM-THORIUM AND URANIUM-THORIUM FUEL (kg/reactor year)

Nuclides	NP-500 $\text{PuO}_2+\text{ThO}_2$	RBMK-1000 UO_2+ThO_2
Annual loading		
^{232}Th	12972.8	48963
^{235}U	-	1447
^{238}U	-	76
^{239}Pu	533.4	-
^{240}Pu	28.3	-
Pu(tot)	561.7	-
Annual discharge		
^{232}Th	12640.0	48195
^{233}U	166.4	426
^{234}U	19.2	29
^{235}U	3.2	600
^{236}U	-	145
^{238}U	-	72
^{239}Pu	40.3	0.07
^{240}Pu	61.8	-
^{241}Pu	40.8	-
^{242}Pu	21.0	-
Pu(tot)	163.9	-

3.5.5.4. Safety problems

Since only preliminary evaluations of different possible thorium fuel cycles have been made, detailed analysis of safety problems of thorium fueled reactors is not available.

The calculation of reactivity coefficients for the NP-500 reactor with plutonium-thorium fuel shows that the presence of large amounts of thorium provides a large negative fuel temperature reactivity coefficient value extremely important for reactor safety. At the operating point, corresponding to the reactor rated power level, the $\Delta\rho/\Delta T_f$ ratio changes from -0.28×10^{-4} to $-0.35 \times 10^{-4}/C$ have been calculated for the core lifetime. The water temperature reactivity coefficient is negative within the whole temperature range, taking into account water density change. Its value ($\Delta\rho/\Delta T_{H_2O}$) at the operating point changes during the core life time from -0.25×10^{-3} to $-0.5 \times 10^{-3}/C$. This is also important for safe reactor operation.

As noted above, the essential feature of a thorium fuel cycle is a high neutron absorption cross section in the thermal energy range, compared to the uranium fuel cycle. This results in a decrease in the individual worth of boron control rods and there is a significant decrease in the value of β_{eff} . These changes require a compensating increase in the total worth of the existing control and safety systems. On the other hand, the higher conversion coefficient in the uranium-thorium cycle with ^{233}U allows lowering the fuel burnup reactivity margin and increases reactor safety. A high absorption cross section in the thermal energy range is favorable with respect to the safety of water cooled reactors with graphite moderator. It causes a considerable decrease in the positive component of the steam reactivity effect without needing to insert additional absorber rods.

3.5.6. USA

Thorium fuel cycles can be analyzed by standard nuclear design methods used for uranium and plutonium fuel cycles by including the appropriate thorium depletion and fission product chains in the calculations. The heavy metal buildup chains which include thorium are shown in Figure 3.5.11 and a typical set of explicit fission products for ^{233}U depletion calculations is shown in Table 3.5.11. Methods of calculation must make accurate resonance integral calculations and ^{233}U has a large enough resonance integral that resonance neutron capture can be comparable to that in ^{232}Th .

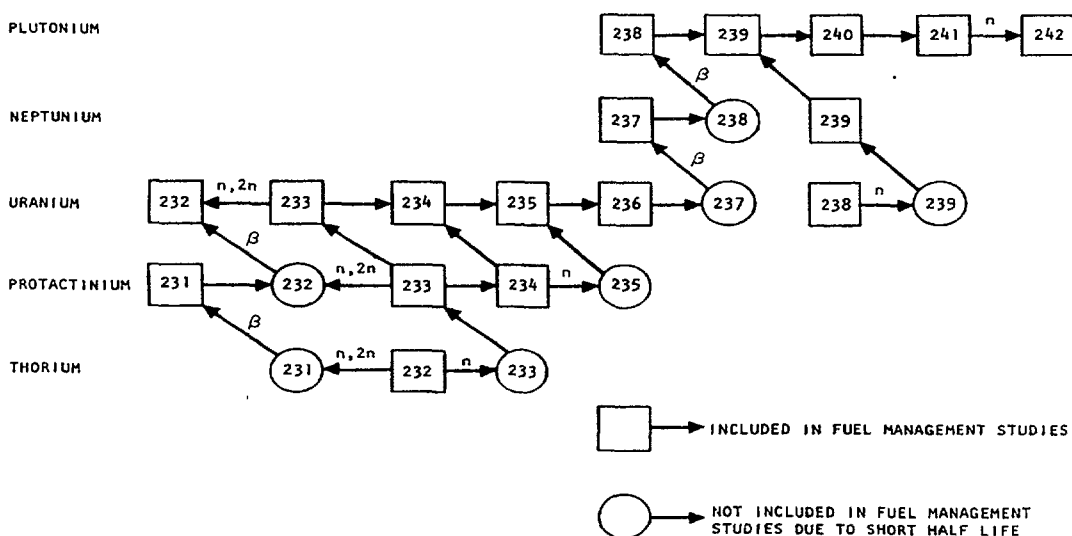

FIG. 3.5.11. Heavy metal buildup chains in HTGR depletion calculations.

For HTGR systems, ^{232}Th and ^{233}U ENDF/B cross-sections (IV and later) yield good agreement with measurements from critical experiments (HTGR, Peach Bottom and HTLTR) and operating reactors (FSV and Peach Bottom). For example, Doppler coefficient calculations for the HTGR critical assembly [3.5/36] agreed with measurements to within 2 per cent $\Delta\rho$ over a wide range of carbon-to-thorium ratios. Measurements of thorium reactivity worth in the assembly were also in excellent agreement with calculations.

For LWRs, analytical methods developed for thorium bearing fuels were evaluated by analysis of BNL light water moderated Th/ ^{235}U fueled exponential and a B&W Th/ ^{235}U fueled critical experiment [3.5/37]. Agreement between theory and experiment was not as good as in normal LWR uranium systems but was good enough for the design calculations underway. For BNL exponentials, the theory and experiment were within 0.3 per cent $\Delta\rho$ at water-to-fuel ratios characteristic of PWRs. With little interest in LWR thorium fuel cycles, no further updating and validation of the methods has been undertaken.

TABLE 3.5.11 TYPICAL EXPLICIT FISSION PRODUCT CHAINS FOR HTGR DEPLETION CALCULATIONS

Fission Product Nuclide	Typical Fractional Absorptions
Xe-131	7.32×10^{-3}
Xe-135	2.25×10^{-2}
Cs-133	7.68×10^{-3}
Mo-95	3.17×10^{-3}
Tc-99	4.32×10^{-3}
Rh-103	8.15×10^{-3}
Nd-143	1.59×10^{-2}
Nd-145	5.08×10^{-3}
Pm-147	5.94×10^{-3}
Pm-148	2.58×10^{-3}
Sm-149	6.43×10^{-3}
Sm-150	2.10×10^{-3}
Sm-151	3.74×10^{-3}
Sm-152	3.32×10^{-3}
Eu-153	2.71×10^{-3}
Eu-154	2.37×10^{-3}
Eu-155	2.28×10^{-3}
NSAG25*	1.11×10^{-2}

* Non-saturating aggregate for ^{235}U .

REFERENCES

- [3.5/1] UNPUBLISHED DATA from AVR-Operators and KFA-Experts on AVR-Operation Experience and Critical Experiments as well as on THTR-Criticality etc., March 1995.
- [3.5/2] THTR-Safety Report, BBC/HRB Report (1975).
- [3.5/3] TEUCHERT, E., "Brennstoffzyklen des Kugelhaufen-Hochtemperaturreaktors in der Computersimulation", KFA-Jülich, Jül-2069 (1986).
- [3.5/4] TEUCHERT, E., "Utilization of the Th-cycle in the High Temperature Reactor", KFA-Jülich (1990).

- [3.5/5] RÜTTEN, H.J., SCHULTEN, R., EUCHERT, E., "Begrenzung der Toxizität von Aktiniden-Waste", KFA-Jülich, Atw Juli (1980).
- [3.5/6] INTERNATIONAL ATOMIC ENERGY AGENCY: SCHLOSSER, G.J., ANDRADE, E.P.; "Brazilian-German investigations on Th-utilization in KWU- type PWR's — results of nuclear core design", IAEA-TECDOC- 344 (1984).
- [3.5/7] KFA/SIEMENS-KWU/NUKEM/NUCLEBRAS, "Program of Research and Development on the Thorium Utilization in PWR's", Final Report (1979–1988), Jül-Spez-488 (1988).
- [3.5/8] PEEHS, M., SCHLOSSER, G., "Prospects of Th-fuel cycles in a standard PWR", Siemens Forsch- u. Entw. Bericht 15, Nr. (1986).
- [3.5/9] SCHLOSSER, G.J., BENDER, D., "Plutonium-Rückführung in Druck- und Siedewasserreaktoren", Siemens KWU, Atw 40, Jg., Heft 3 (1995).
- [3.5/10] DERRIEN, H., "R-Matrix analysis of neutron effective total cross section, fission cross section, and capture cross section of ^{233}U in the energy range from thermal to 150 keV", J. Nucl. Sci. Technol. **31** (1994) 379.
- [3.5/11] MADLAND, D.G., NIX, J.R., "New calculation of prompt fission neutron spectra and average prompt neutron multiplicities", Nucl. Sci. Eng. **81** (1982) 213.
- [3.5/12] SMITH, A. B., et al., "On the neutron inelastic scattering cross sections of ^{232}Th , ^{233}U , ^{235}U , ^{238}U , ^{239}Pu and ^{240}Pu ", (Proc. Int. Conf. Antwerp, 1982) Nuclear Data for Science and Technology, Antwerp (1982) 39.
- [3.5/13] TAKANO, H., "Benchmark tests of JENDL-3.2 for thermal and fast reactors", Proc. Int. Conf. on Nuclear Data for Science and Technology, Gatlinburg, Vol.2 (1994) 809.
- [3.5/14] OHSAWA, T., SHIBATA, T., "Evaluation of fission neutron spectra for minor actinides", *ibid.*, Vol.2 (1994) 639.
- [3.5/15] STAROSTOV, B. I., et al., "Precise measurements of fission prompt neutron spectra for Cf252, etc", Proc. All-Union Conf. on Neutron Physics, Kiev, Vol.2 (1983) 290.
- [3.5/16] KOBAYASHI, K., "Reactivity measurements in a thorium critical assembly", Nucl. Sci. Eng., **71** (1979) 143.
- [3.5/17] MISAWA, T., "Measurement of the reactivity effect of beryllium metal in the KUCA", Ann. Rep. Res. Reactor Inst. Kyoto Univ., **18** (1985) 143.
- [3.5/18] NISHIGORI, T., et al., "Some nuclear characteristics of thorium fueled light water reactors", J. Nucl. Sci. Technol. **25** (1988) 943.
- [3.5/19] TSUCHIHASHI, K., et al., "Revised SRAC Code System", JAERI 1302, (1986).
- [3.5/20] GROFF, A.G., "ORIGEN 2: Versatile computer code for calculating the nuclide composition and characteristics of nuclear materials", Nuc. Technol., **62** (1983) 335.
- [3.5/21] SEKIMOTO, H., TAKAGI, N., "Preliminary study on future society in nuclear quasi-equilibrium", J. Nucl. Sci. Technol. **28** (1991) p.941–946.
- [3.5/22] SEKIMOTO, H., et al., "Nuclear system research and development in the next century toward an equilibrium state", Proc. GLOBAL'93, Vol. 1, Seattle (1993) p.283–287.
- [3.5/23] SEKIMOTO, H., "Physics of future equilibrium state of nuclear energy utilization", Proc., Int. Conf. on Reactor Physics and Reactor Computation, Tel-Aviv, Israel (1994) p.515–523.
- [3.5/24] TAKAGI, N., SEKIMOTO, H., "Feasibility of fast fission system confining long lived nuclides", J. Nucl. Sci. Technol. **29** (1992) p.276–283.
- [3.5/25] SEKIMOTO, H., et al., "Toxicity of Radioactive Waste Discharged from Nuclear Energy Center in the Future Equilibrium State", Ann. Nucl. Energy, (in press).
- [3.5/26] ICRP Publication 30, "Limits for Intakes of Radionuclides by Workers", Pergamon Press, Oxford (1979).

- [3.5/27] TAKAGI, N., et al., "Future equilibrium synergic system using fast and thermal reactors with U and Th mixed fuel cycle to enhance potentials on fuel and waste balances", Proc., GLOBAL'93, Vol. 1, Seattle (1993) p.222-228.
- [3.5/28] ASKEW, J., General description of lattice code WIMS, Journ. Brit. Nucl. Energy. Soc., V.5 (1966) 554.
- [3.5/29] BLOKHIN, A.L., et al., "Current status of Russian evaluated neutron data library", Proc. Conf. on Nucl. Data for Science and Technology, Gatlinburg (1994).
- [3.5/30] ROSE, P.F., ENDF/B-6 Summary Documentation, ENDF-201, BNL-NCS- 17541 (1991).
- [3.5/31] JAPANESE EVALUATED NUCLEAR DATA LIBRARY, Version 3, JENDL-3, Jafri 1319 (1990).
- [3.5/32] NIKOLAEV, M.N., et al., "New nuclear constant ABBN-90 and its test on basis of macroscopic experiments", Proc. Conf. on Nucl. Data for Science and TECHNOLOGY JÜLICH (1991).
- [3.5/33] MUGHABGHAB, S.F., DIVADEEMAN, M., HOLDEN, N.E., 'Neutron Cross Section', Vol.1, Part B, Academic Press (1981).
- [3.5/34] ZVONAREV, A.V., et al., "Measurement of average cross section ratios in BN- 350 reactor with metallic uranium insertion", VANT, Series: Nuclear Data, V.1 (1991) 79.
- [3.5/35] ILYUNIN, V., MAGAEV, A., ZIABLETSEV, D., "Physics of fast reactor-converter Pu to ^{233}U ", IAEA Meeting on Unconventional Options for Plutonium Consumption, , Obninsk, Russian Federation (1994).
- [3.5/36] MERRILL, MELDON H., "Nuclear Design Methods and Experimental Data in Use at Gulf General Atomic", Gulf-GA-A12652 (1973).
- [3.5/37] EPRI, "Assessment of Thorium Fuel Cycles in Pressurized Water Reactors", report NP-359 (1977).

3.6. FUEL CYCLE TECHNOLOGIES (Th-RESOURCES; PROSPECTING AND MINING; Th-FUEL FABRICATION; FUEL PERFORMANCE; REPROCESSING)

3.6.1. Germany

3.6.1.1. Th-resources, prospecting and mining

Thorium occurs in association with uranium and rare earth elements in diverse rock types. It occurs as veins of thorite/Urano-thorite and monazite in granites, syenites, and pegmatites. Monazite also occurs in quartz-pebble conglomerates, sandstones and fluvial or beach placers. Moreover, Th occurs along with rare earth elements in bastnaesite and in the carbonatites [3.6/1]. Present knowledge of worldwide Th-resources is still poor because of inadequate exploration efforts and to insignificant demand. However, it is estimated that the total Thorium resources are somewhat larger than those of Uranium.

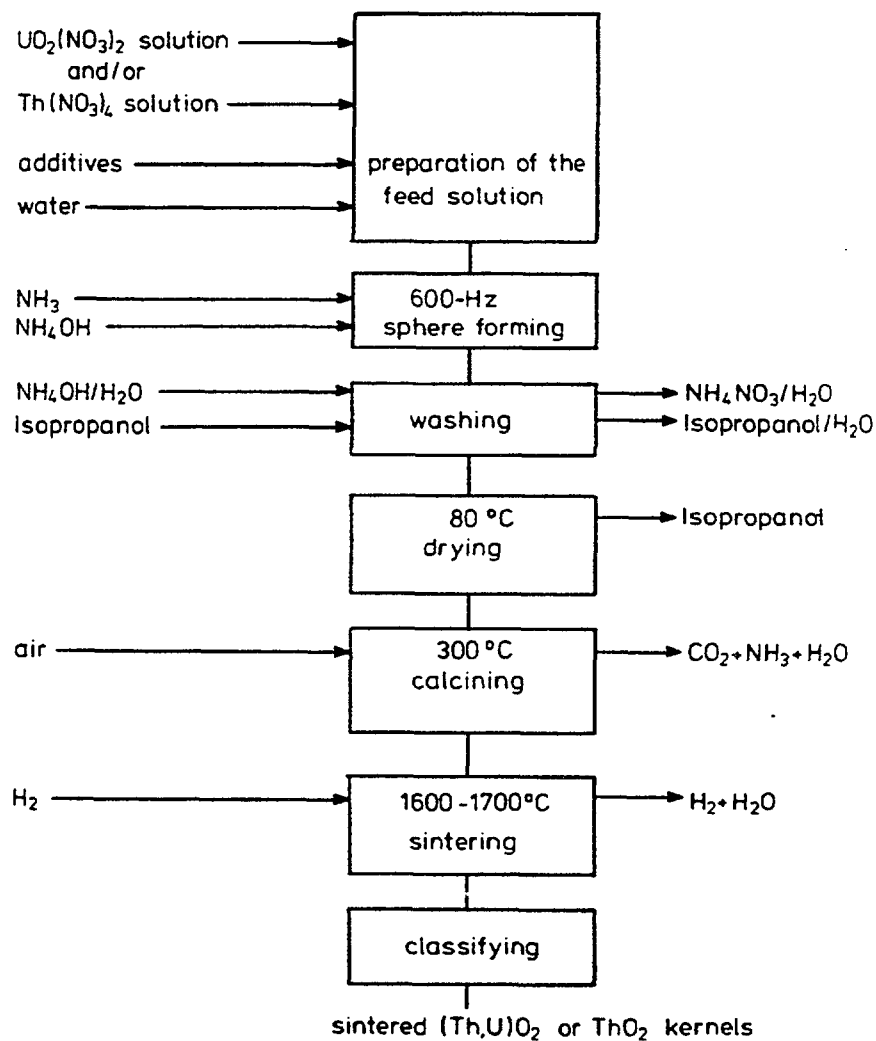

FIG. 3.6.1. Flowsheet of process to produce (ThU) O₂ or ThO₂ kernels ($t_k = T_c + 273$).

3.6.1.2. Fuel fabrication

In Germany and the USA, fuel fabrication technology for the use of Th in HTRs or HTGRs [3.6/2], in PWRs and light water breeder reactors (LWBR), is based on proven HTR-technology for manufacturing UC_2 -, UCO -, UO_2 -, ThO_2 -, $(ThU)O_2$ -, $(ThO_2)(ThU)O_2$ - and PuO_2 -kernels. Subsequently, coating is done with different C- layers and/or a SiC-layer (BISO or TRISO), as in proven LWR fuel fabrication technology, along with pelletizing ThO_2 -based fuel into calcinated kernels. Procedures and equipment for the remote production of coated particles or pellets (for ^{233}U - or Pu-fuel) have been developed and successfully tested. This shielded and remote operation is required for the re-fabrication of reprocessed ^{233}U - and Pu-fuel [3.6/3 to 3.6/7]. The basic process flow scheme for production of (Th, U) O_2 - or ThO_2 -kernels is in Figure 3.6.1. Figure 3.6.2. shows a simplified flow scheme for the combination of HTR- and LWR-technologies for production of different Th-based fuels.

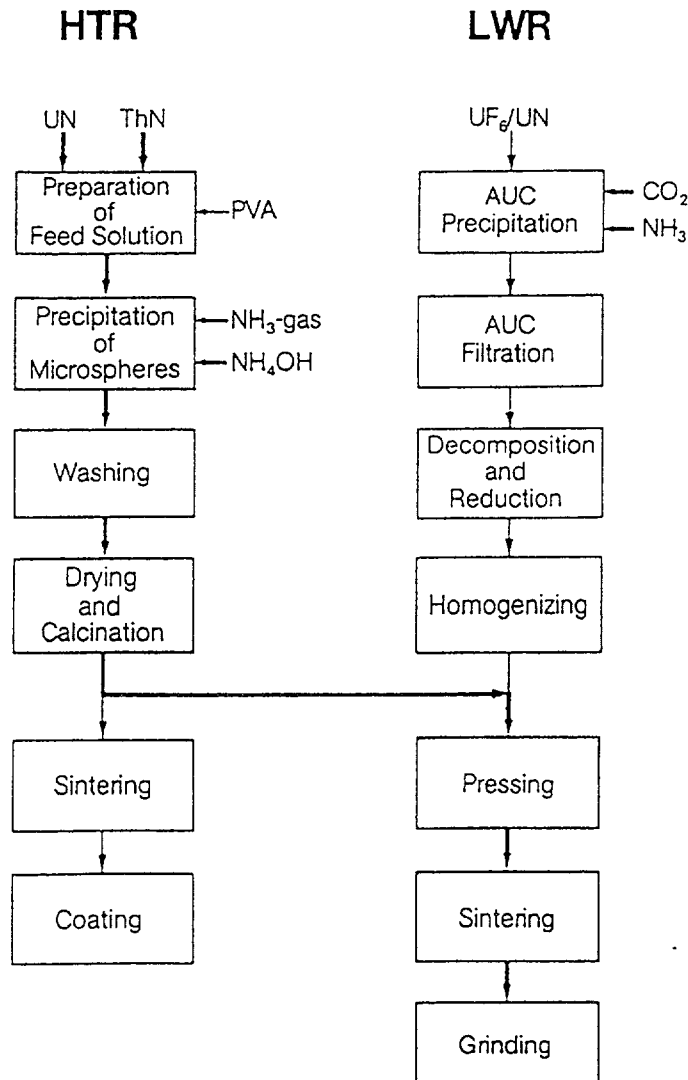

FIG. 3.6.2. Combination of available technologies for the manufacturing of mixed-oxide fuel for HTRs or PWRs.

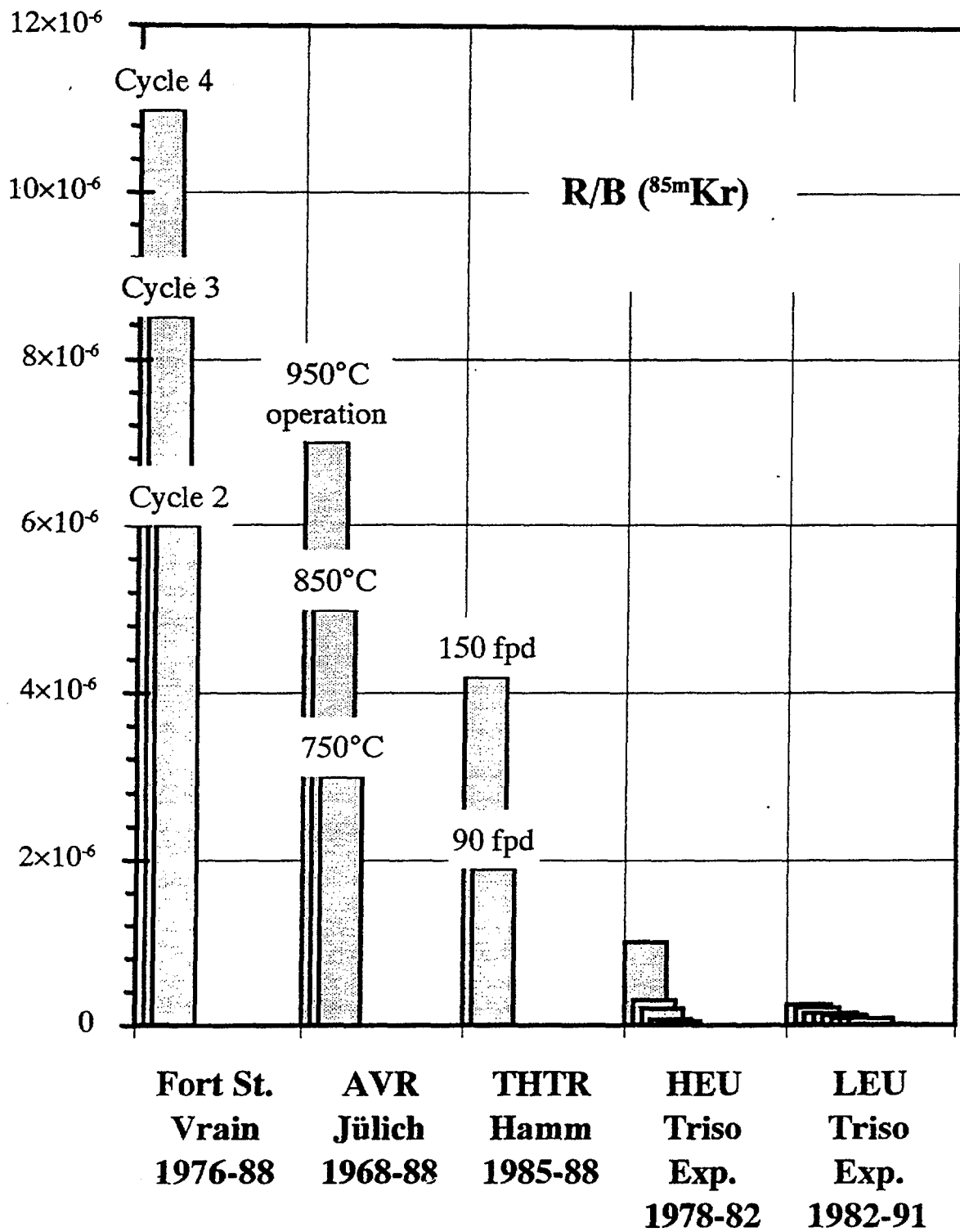

FIG. 3.6.3. Fission gas release rates in power stations Fort St. Vrain, AVR, THTR and in irradiation experiments with modern, high quality, TRISO fuels.

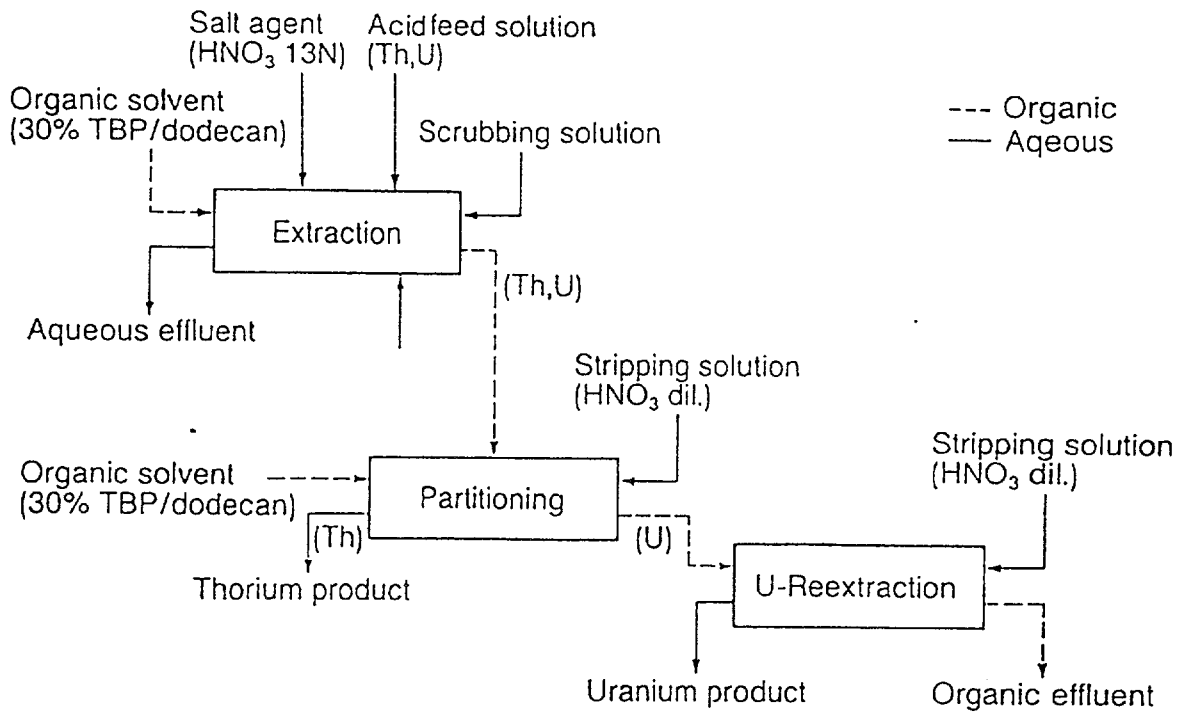

FIG. 3.6.4. One cycle thorex process.

3.6.1.3. Fuel performance

Especially if TRISO-coated with SiC as a third layer, fuel particles showed excellent performance under irradiation tests and reactor operating conditions [3.6/8]. This is true for all fuel kernels, whether UO_2 , ThO_2 , $(\text{ThU})\text{O}_2$, UC_2 or UCO . Under accident conditions, peak fuel temperatures for TRISO-coated particles are kept at or below 1600C. This is well below the 2000C limit at which significant fission product release has been measured. Figure 3.6.3 shows typical fuel performance under reactor operating conditions and in irradiation experiments in material test reactors at nominal operating conditions, using the R/B of $^{85}\text{Krypton}$. (Note: R = release rate, B = birth rate). Behavior of Th-based fuel in PWRs was tested in the USA and Europe at heat loads up to 680 W/cm fuel rod length and to burnup of 80,000 MWd/tHM. The Th-based fuel performed excellently compared to standard LWR-fuel.

3.6.1.4. Reprocessing

Spent fuel storage assessment

Spent fuel storage for the AVR and THTR reactors was designed for all kinds of fuels or fuel mixtures. Thus, the use of Th-based fuel did not require special design or cooling measures. In existing PWRs, the use of the existing spent fuel storage facilities (wet or dry) and transportation equipment was investigated regarding Th-based fuel. Existing designs were shown to be adequate.

The Thorex process was developed to reprocess Th-based coated or uncoated fuel particles up to a burnup of 100,000 MWd/tHM. This process was successfully tested in a laboratory and in pilot plants at KFA, Jülich, and other states. The optimum flow scheme chosen for the Thorex process for Th-based fuel is in Figure 3.6.4.

3.6.2. India

3.6.2.1. Thorium resources, prospecting and mining

Most of India's thorium reserves are the nearly 300,000 tons of thorium in the beach sands of Kerala and Orissa. The ore is very high grade with a thorium content of about 10 per cent. Since they are in the beach sands, they lie close to the surface and mining is easy. Similar extensive deposits are present in Brazil, Canada and USA. The first industrial activity of the Department of Atomic Energy of India was to exploit the Kerala beach sands. This was done by Indian Rare Earths largely for non-nuclear industrial uses of thorium and other rare earth minerals. Thorium for R&D and later, for initial power flattening in PHWRs was easily available.

Elsewhere, the scenario is likely to be much the same. With THTR and Shippingport having closed down, great demand for thorium is unlikely so neither is there likely to be much prospecting for thorium. Mines already open will be exploited as needed. However, uranium prospecting continues in India and other countries and due to similarities in radioactive properties, prospectors often stumble on thorium deposits.

3.6.2.2. Thorium fuel fabrication

Indian experience with thorium dates back to when a 40 MW research reactor CIRUS was commissioned and thorium fuel rods were introduced into peripheral core locations. Experience in thorium and thoria-based fuel test rods was broadened when about 2.5 tons of high density sintered thoria pellets were fabricated. This technology was then transferred to a commercial plant, the Nuclear Fuel Complex. A considerable quantity of thoria elements was fabricated there and supplied as blanket elements for the LOTUS facility in Switzerland. A fair number of thorium oxide fuel bundles were fabricated and loaded into the two units of the Kakrapar Atomic Power Station.

The PHWR fuel pins should be high density (>96 per cent TD) with a microstructure of uniformly distributed, nearly spherical "closed" pores in the diameter range of 2–5 microns, for improved burnup and satisfactory reactor performance. A major difficulty in using ^{233}U fuels is the high radiation and dose problem; U-233 is always associated with traces of ^{232}U giving rise to highly penetrating, gamma emitting daughter products. Unlike natural uranium and thorium, ^{233}U fuel must be fabricated remotely, with proper containment either inside shielded glove boxes or hot cells to keep operator exposure at low levels.

Scientists in India recently developed the sol-gel microsphere pelletization (SGMP) process, ideally suitable for remote and automated fabrication of thorium based, highly radiotoxic, oxide fuels. In this process, sol-gel derived, calcined, oxide microspheres, rather than fine powder-derived granules, are used for pellet pressing and sintering [3.6/16; 3.6/17]. Thus, radiotoxic dusts and aerosols are avoided and process losses minimized. The process is easy to remotely manipulate because the microspheres are dust free and free flowing. A high

degree of micro-homogeneity is attained in fuel pellets because the mixing of heavy metals is in nitrate solution forms. Finally, this SGMP route obtains fuel pellets of high density with a desirable microstructure.

The sol-gel process is increasingly used to make fine, homogeneous ceramic powders for a variety of applications. A recent innovation involves preparation of soft thorium oxide or thorium uranium MOX microspheres for making fuel pellets. Superior microstructure and porosity distribution of the pellets obtained by this method has the potential for superior reactor performance. Thorium fuel is also produced by two alternative methods: cold pelletizing and sintering, and the pellet impregnation method used for (Th + U) mixed oxide. The latter uses an interesting technique in which Th oxide pellets of low density are suspended in a high temperature, uranyl nitrate bath where it soaks up ^{233}U .

The conventional powder-pellet route involves simultaneous mixing-grinding of ThO_2 powder with UO_2 or PuO_2 powders, granulation, cold-pelletization of granules at ~ 350 MPa, and high temperature (~ 1973 K) sintering of pellets in $\text{Ar}+8\%\text{H}_2$ atmosphere. ThO_2 and PuO_2 powders are produced by air-calcination of the oxalates. These powders are extremely fine (<1 micron) with poor flow characteristics. Likewise, UO_2 powder produced via the ammonium diuranate route is fine and not free flowing. Further, the platelet morphology of oxalate derived ThO_2 powder causes homogeneity problems while mixing with UO_2 or PuO_2 powders.

Some modifications were made in the conventional "powder-pellet" route to prepare $\text{ThO}_2\text{-UO}_2$ and $\text{ThO}_2\text{-PuO}_2$ pellets of high density and good homogeneity. Thorium nitrate feed solution was doped with ~ 1 wt% magnesium sulfate or nitrate before precipitation of thorium oxalate to get ~ 0.4 wt% MgO as a "sintering aid" in the calcined ThO_2 powder. Pre-milling the oxalate-derived ThO_2 powder to break the platelet morphology before milling with UO_2 or PuO_2 ensures proper homogenization of oxide powder mixtures. Approximately 0.25 w/o Nb_2O_5 is mixed with the $\text{ThO}_2\text{-UO}_2$ and $\text{ThO}_2\text{-PuO}_2$ powders to improve sinterability.

With MgO doped ThO_2 powder, it was possible to achieve high pellet density for $\text{ThO}_2\text{-UO}_2$ and $\text{ThO}_2\text{-4\% PuO}_2$ pellets at a relatively low sintering temperature of (<1773 K). The Th^{4+} is partially replaced by Mg^{2+} ions causing the formation of oxygen or anion vacancies, enhancing the volume diffusion of thorium ions and leading to rapid density increases of $\text{ThO}_2\text{-UO}_2$ or $\text{ThO}_2\text{-PuO}_2$ at a relatively low sintering temperature.

Cermet fuel is an advanced concept considered for thorium. It uses kernels of uranium oxide coated with nickel and chromium dispersed in a matrix of thorium metal. Some success has been achieved in nickel coating uranium oxide microspheres.

Other R&D performed at Trombay on thorium in power reactors is evaluating the thermal diffusivity and hot hardness of thorium oxide, plus 4 per cent plutonium oxide and thorium oxide, plus 2 per cent uranium oxide. Data from these experiments are necessary to estimate the maximum heat rating these fuel elements can stand.

R&D on thorium fuel fabrication in India is two-pronged: one route is to follow the powder metallurgy process and the other, the sol-gel microsphere pelletization process. Development of the sol-gel process started from the work at Juelich, Germany for the pebble bed HTGR. The process used by KFA, Juelich, was modified in many ways. Some major changes were the addition of carbon black to the sol so that the microspheres produced are

more porous. The highest density achieved without adding carbon black was only about 83 per cent of theoretical density (TD). Another modification was the addition of about 1 per cent calcium nitrate in the feed solution to improve the sintering capability of the calcined microspheres.

3.6.2.3. Fuel performance

The performance targets thorium fuel is expected to meet depend on the specific fuel cycle for which it is intended. The requirements of thorium fuel for a low burnup, near-breeder-type of cycle are bound to differ from those for high burnup, once through cycles.

Irradiation of thorium fuel elements in India started in the CIRUS research reactor. This 40 MW research reactor has 64 positions for loading thorium fuel rods. A number of thorium metal fuel rods, and a larger number of thorium oxide fuel rods, were fabricated and irradiated in CIRUS reactor. A few thorium oxide pellets were used in the 100 MW research reactor Dhruva.

The first regular use of thorium oxide fuel for power in India was at the Kakrapar pressurized heavy water reactor. The initial core used 35 thorium oxide fuel bundles to achieve the required power flattening while earlier PHWR reactors in the world used depleted uranium in the initial core. Before this extensive use of thorium began in Kakrapar, performance testing of thorium bundles in power reactors was done in May 1985 by loading four thorium bundles in the Madras Atomic Power Station. These bundles were unloaded during the usual refueling operation and by then, the thorium bundles had been in the core for 280 effective full power days. The bundle with the highest fuel burnup received 1700 MWd/t.

CIRUS reactor has an in-core loop for fuel irradiation. This loop, the pressurized water loop (PWL), was used extensively to test thorium fuel. A fuel assembly containing thorium oxide and plutonium oxide was irradiated in the PWL for almost three years from May 1985 to January 1988. The highest heat rating that the fuel pins experienced was 385 W/cm. The power was raised with no restriction until the heat rating reached 325 W/cm. Subsequently it was raised in steps of 4 W/cm with an interval of 2 hours between each increase. The fuel cluster was subjected to about 100 power cycles as well. When the cluster was removed the thorium-plutonium mixed oxide fuel pins had undergone a burnup of about 18 500 MWd/t.

Subsequently, in 1992, a string of two six-pin clusters was loaded into the CIRUS PWL. One of these clusters consisted of six pins of unenriched thorium; the other was a composite cluster of two pins of $\text{ThO}_2\text{-PuO}_2$, two of $\text{UO}_2\text{-PuO}_2$, and two natural uranium pins. The Pu content was about 4 per cent, and the heat rating of the $\text{ThO}_2\text{-PuO}_2$ pins was 500 W/cm. The objective of this irradiation was to prove the PHWR design of $\text{UO}_2\text{-PuO}_2$ and $\text{ThO}_2\text{-PuO}_2$ pins at high burnups; to improve understanding of the fuel behavior using advanced fuel cycles and to benchmark the fuel design codes. At this writing, this assembly is still in the CIRUS PWL. The next assembly installed in CIRUS will be similar; the difference is that pellets will be fabricated by other methods (low temperature sintering, sol-gel, etc.)

3.6.2.4. Reprocessing

As described above, thorium fuel rods have been in the CIRUS core since the early sixties. The thorium-fuel rods loaded in the CIRUS reactor were commonly referred to as the J rods. A facility was set up at Trombay during the late 60s to separate the ^{233}U from the irradiated J rods.

The Thorex process uses tributyl phosphate, an organic solvent. Chemical reprocessing yields essentially pure ^{233}U with traces of ^{232}U . Though the parts per million (ppm) concentration of ^{232}U in the fresh recovered ^{233}U is not significant of itself; a serious problem arises due to the decay products of ^{232}U , especially ^{228}Th . As a result of the decay products of ^{232}U , the gamma activity of separated ^{233}U continues to increase for about 10 years. Because of the high activity from the buildup of ^{228}Th , it is very undesirable to reprocess irradiated thorium, recover the ^{233}U , and store the recovered ^{233}U . Buildup of ^{228}Th requires neutron shielding and shielding from high-energy gamma rays. Alpha particles emitted from the decay of ^{233}U , ^{232}U , and ^{228}Th interact with light elements like carbon and oxygen releasing neutrons in the process. Thus, it is essential to minimize the interval between the separation of ^{233}U and re-fabrication into fuel elements and this must occur as early as feasible after recovery.

Another aspect of thorium reprocessing relates to re-fabrication of the thorium separated from irradiated fuel. The separated thorium contains enough ^{228}Th to make re-fabrication as complex as the fabrication of ^{233}U bearing fuel. It has been observed that if the thorium is stored for about 16 years, the activity will decrease to acceptable levels. At the present state of the art, the losses during reprocessing are of the order of 1 per cent.

3.6.3. Japan

3.6.2.1. *Th fuel fabrication*

3.6.2.1.1. Sol-gel process studies

In 1975–1994, a sol-gel process to prepare Th-based oxide microspheres and pellets was studied at the Japan Atomic Energy Research Institute. The areas studied so far were divided as follows:

- (a) preparation of ThO_2 and $\text{ThO}_2\text{-UO}_3$ sol under pH control to determine colloid particle size;
- (b) gelation of sol drops into micro-spheres in CCl_4 media;
- (c) sintering behavior and density control of the microspheres; and
- (d) preparation of high density pellets by a sol-gel microsphere pelletization (SGMP) process.

The main results in areas (a) and (b) were briefly reviewed in a previous IAEA-TECDOC in 1990 [3.6/18].

Sintering behavior and density control of the microspheres (area c)

The effects of sulfur impurities and heating atmosphere on the densification of ThO_2 microspheres were studied. A sulfur content of 0.3 wt% S/ ThO_2 was introduced in the form of sulfate in the source $\text{Th}(\text{NO}_3)_4$. With sulfur present, the densification of ThO_2 microspheres sintered at 1300C ranged from 91–99 per cent of theoretical density (TD) depending on the steam concentration in the heating atmosphere of the air-steam mixture. In the sulfur-free case, it was always above 99 per cent TD over the entire range of steam concentration [3.6/19]. Using the sulfur-free source, the effect of the heating atmospheres of steam, air and $\text{Ar-4}\%\text{H}_2$ on the densification of ThO_2 and $(\text{Th,U})\text{O}_2$ microspheres were studied in detail [3.6/20]

In any atmosphere the density reached above 99 per cent TD at 1300C, but the densification proceeded differently (See Fig. 3.6.5). $\text{Ar-4}\%\text{H}_2$ produced >99 per cent TD at the lowest temperature, while steam produced >99 per cent TD at the highest temperature. The order of easy densification, i.e. $\text{Ar-4}\%\text{H}_2 > \text{air} > \text{steam}$, is in contrast to that for the ordinary

cold-pressed powder compacts of U or Th-U oxide. The microstructure change during the densification was examined.

The microstructure was characterized using the average diameters of pores (D_p) and grain agglomerates (D_g), calculated from the observed values of apparent and bulk densities and specific surface area. In Ar-4% H_2 , the densification, or increase of D_g , proceeded with D_p kept below 10 nm. In steam or air, the microstructure for high U-content was degraded first as both D_p and D_g increased, with little increase in density. Thereafter, the overall densification proceeded at high temperatures (See Fig. 3.6.6). Moreover, it was found that the order of the ability in densifying the microspheres, once they were degraded to $D_p > 30$ nm by preheating in either air or steam at low temperatures, was inverse, i.e., steam > air > Ar-4% H_2 . The abnormal trend of the sol-gel microsphere densification was attributed to the special microstructure with very fine grains and pores.

Preparation of high density pellets by a sol-gel microsphere pelletization (SGMP) process (area d)

Adding two new techniques in Steps (4) and (7) developed the SGMP process. This consisted of the following procedures: (1) sol preparation, (2) gelation, (3) washing, (4) substituting isopropanol (IPA) for water in the gel, (5) drying, (6) heat-treating, (7) humidifying, (8) pressing and (9) sintering. The IPA substitution caused soft products with about 20 per cent TD, even after heat-treatment at 300C and improved their compactability without degradation of the excellent sinterability of sol-gel microspheres. The moisture added by the humidification acted as a lubricant and a binder, and aided crack free compaction and sintering. By sintering at the low temperature of 1300C in air or Ar-4% H_2 , high density pellets of (Th,U) O_2 (99%TD) [3.6/21] and ThO_2 (98%TD) were obtained.

3.6.3.1.2. New thorium hydride fuel development studies

U-Th-Ti-Zr alloys were investigated [3.6/22 to 3.6/24] to develop a new hydride-base nuclear fuel. The alloy specimens were prepared by arc melting. Hydrogen absorption experiments were performed using Sieverts' method at temperatures between 773 and 1073 K, and at hydrogen pressures between 10^3 and 10^5 Pa. After hydrogenation, the phases in the specimens were identified by X ray diffraction and by the scanning electron microscope (SEM) with energy-dispersive X ray spectroscopy (EDS).

Figure 3.6.7 shows histories of equilibrium conditions confirmed in the hydrogen absorption experiments: Experiment 1a, experiment 1b and experiment 2. The hydrogen concentration at each equilibrium point was labeled beside the marker, representing a value of x in the composition formula of the alloy $UThTi_2Zr_2H_x$. In the figure, the temperature dependence of hydrogen equilibrium pressures in Th-H, Zr-H, $ThZr_2$ -H and UTi_2 -H systems are also shown. In the latter two systems, pressures of $ThZr_2H_{4.2}$ and UTi_2H_4 are shown, while the plateau pressures in the P-C-isotherms are shown in others. For example, the line "Th and ThH_2 " shows the equilibrium pressure when Th and ThH_2 phases coexist. When the experimental pressure is below it, the Th phase is dominant, while when above it, the ThH_2 phase is dominant.

In experiment 1a, the specimen absorbed hydrogen until the concentration reached 7.5 at 973 K and 10^5 Pa and increased to 8.9 by cooling to 773 K. In experiment 1b, the hydrogen concentration reached 4.2 at 1023 K and 10^3 Pa, increased to 5.4 by cooling to 873 K, and reached 9.7 at 773 K and 10^5 Pa. In X ray diffraction patterns of specimens after experiment,

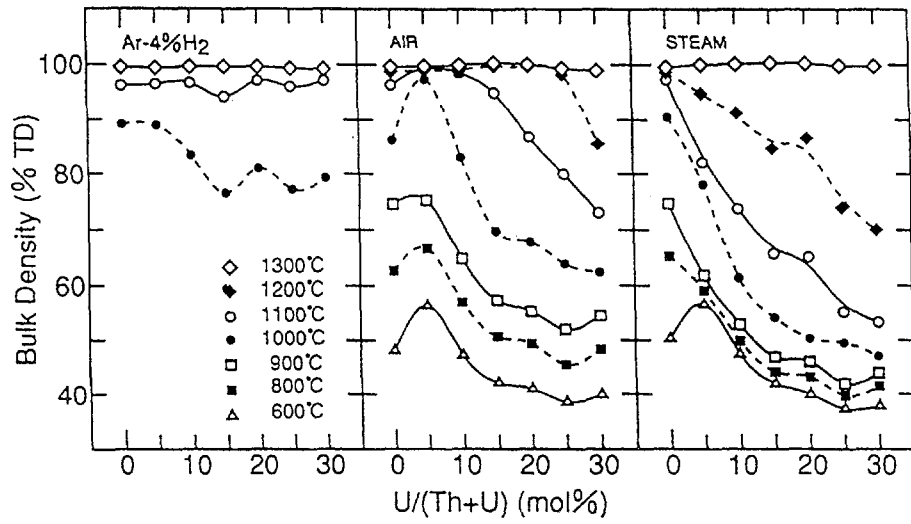

FIG. 3.6.5. Bulk densities of $(Th, U)O_2$ micro spheres heated in AR-4% H_2 air or steam.

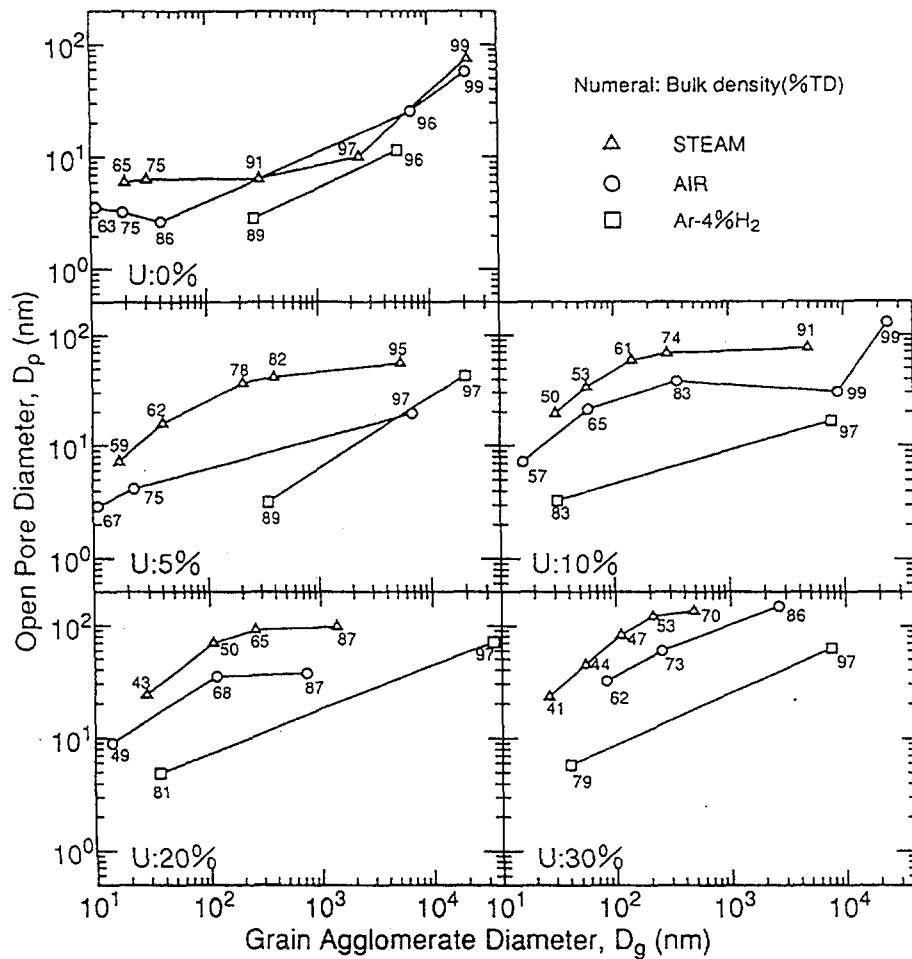

FIG. 3.6.6. Effect of heating atmosphere on the course of sintering of $(Th, U)O_2$ micro spheres.

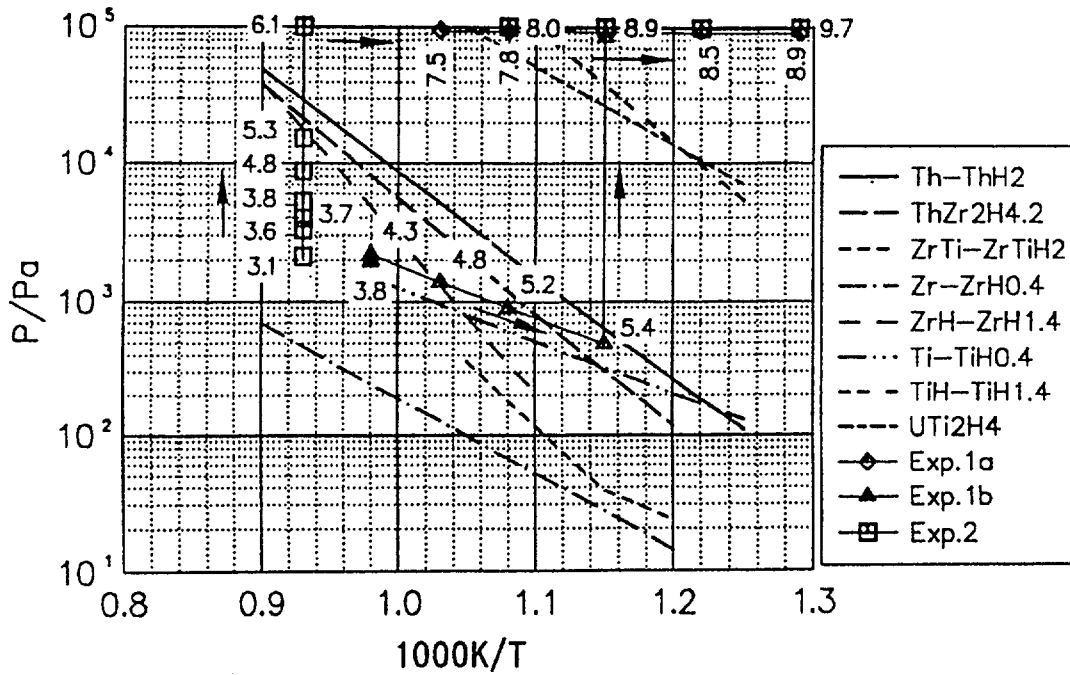

FIG. 3.6.7. Histories of equilibrium conditions in the experiments with p - $1/T$ relations of various M - H systems.

the intensity of ThH_2 peaks decreased and those of $\text{ThZr}_2\text{H}_{7-x}$ increased from experiment 1a to experiment 1b. In both patterns, peaks of U and $\text{ZrTiH}_{1.8}$ were also observed.

In experiment 2, the specimen was hydrogenated until the composition became $\text{UThTi}_2\text{Zr}_2\text{H}_{5.3}$ at 1073K and 10^3 to 10^4 Pa and finally the H content reached 9.7. X ray diffraction and SEM-EDS analysis revealed that the hydrogenated specimen consisted of three components; $\text{Th}(\text{Zr}_{1-y}\text{Ti}_y)_2\text{H}_x$ phase (ThZr_2H_x -type), $\text{Ti}_{1-y}\text{Zr}_y\text{H}_x$ phase ($\text{TiZrH}_{1.8}$ -type) and the mixture of U phase and UTi_2H_x phase. These results suggest that due to the hydrogenation of $\text{UThTi}_2\text{Zr}_2$ alloy, the ThZr_2H_x -type phase and ZrTiH_x -type phase were very stable and were formed as first and second steps of the reactions, respectively, leaving a phase of U-rich U-Ti alloy which finally formed UTi_2H_x and U phases.

Although such a complicated multi-phase alloy was formed by hydrogenation, it was perfectly metallic and was obtained with no cracks. Further, the hydrogen equilibrium pressures of $\text{Th}(\text{Zr},\text{Ti})_2$ and $(\text{Zr},\text{Ti})\text{H}_x$ phases were as low as that of $\text{ZrH-ZrH}_{1.4}$. Therefore, if the hydrogenated alloy of a single or a pseudo-single phase, such as in the present study, is obtained by varying alloying rates of the elements, a candidate alloy will be obtained to be utilized as a Th-U fuel.

3.6.3.2. Fuel performance

3.6.3.2.1. HTGR fuel performance

Thorium fuel performance was studied in the HTGR development program at the Japan Atomic Energy Research Institute. These studies focused on fission product behavior and irradiation performance of thorium or thorium-uranium mixed oxide in microsphere form.

A relation between the release behavior of metallic fission-products and grain size in highly irradiated $(\text{Th}_{0.94}, \text{U}_{0.06})\text{O}_2$ was investigated using TRISO coated fuel particles for HTGRs, in post-annealing experiments [3.6/25]. Internal releases of Cs, Ba, Te and I from $(\text{Th}_{0.94}, \text{U}_{0.06})\text{O}_2$ kernels, having grain sizes from 23.7 to 76 μm , were measured in a temperature range from 1700–2000 $^\circ\text{C}$. Typical results for the fractional release as a function of grain size are shown in Figure 3.6.8. This shows that fractional releases of the volatile (Cs, Te, I) and the alkali earth (Ba) fission products depends strongly on grain size, as predicted by the Booth model. However, metallic fission products (Zr, Ce) soluble in the fuel matrix, show low releases without any grain-size dependence attributable to direct recoil. The fractional releases of volatile and alkali-earth fission products had a good correlation with grain size.

Cs diffusion coefficients in activated (less than 0.005% FIMA), and slightly irradiated (0.15% FIMA) (Th, U) O_2 microspheres, were evaluated by measuring the fractional releases during post-irradiation annealing in a temperature range from 1200–1500 $^\circ\text{C}$ [3.6/26]. The Cs diffusion coefficients depended significantly on burnup, as shown in Figure 3.6.9.

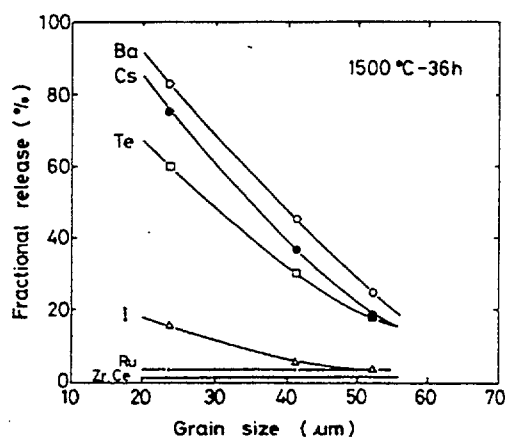

FIG. 3.6.8. Grain size dependence of the internal release for 1500 $^\circ\text{C}$ - 36h heating.

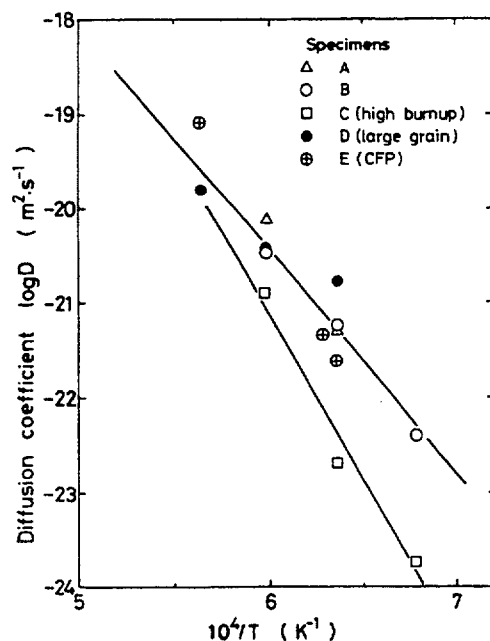

FIG. 3.6.9. Arrhenius plot of Cs diffusion release for 1500 $^\circ\text{C}$ - 36h heating coefficient calculated by the Booth model.

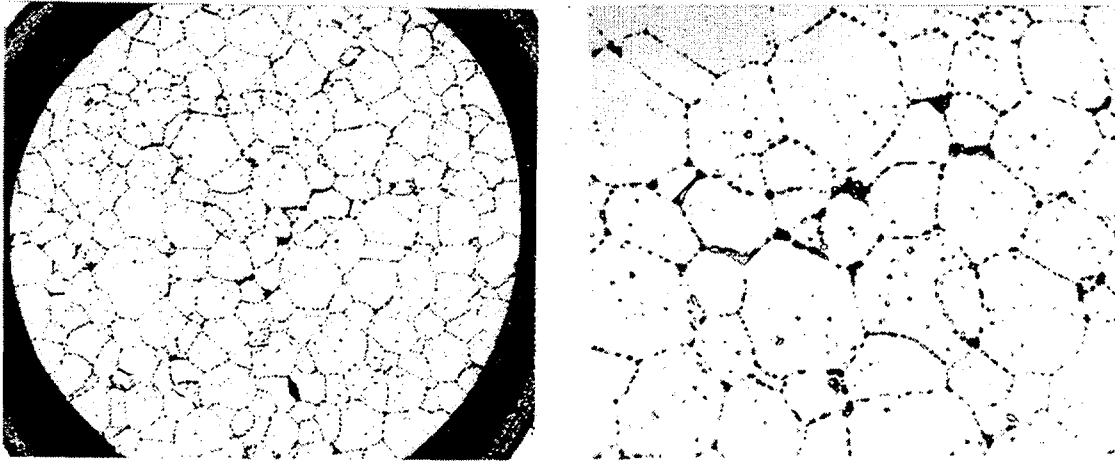

FIG. 3.6.10. Typical microstructure of $(Th, U)O_2$ kernel in the coated fuel particles irradiated high burnup.

Irradiation performance

Irradiation tests of TRISO coated ThO_2 and $(Th, U)O_2$ particles were conducted using three capsules in JMTR (Japan Material Test Reactor) [3.6/27] and in JRR-2 (Japan Research Reactor 2). Irradiation tests in JMTR were conducted under varying conditions with maximum temperatures of 1390 °C, and maximum burnup of 7.3% FIMA for $(Th, U)O_2$ and 0.32% FIMA for ThO_2 . In post-irradiation examination, the coated-particle fuels were tested to determine fuel behavior, such as the amoeba effect (kernel migration under a temperature gradient), and coated-particle integrity at high burnup and in very high temperature post-irradiation heating.

A severe amoeba effect was observed in TRISO $(Th_{0.8}, U_{0.2})O_2$ coated fuel particles, which had been irradiated up to 3.7–6.6% FIMA, under high temperature gradients of 250 °C at approximately 1300 °C. Many grain-boundary pores, in-grain pores, and metallic precipitates composed of Mo-Tc-Ru-Rh-Pd, were observed at high burnup (Fig. 3.6.10). A significant progression of grain growth and grain-boundary pores was also observed in ThO_2 fertile particles irradiated to 0.32% FIMA at approximately 1300 °C. In post-irradiation heating up to 2300 °C, no failure was detected among 100 particles tested.

3.6.3.2.2. Oxygen chemical diffusion in $(Th, U)O_2$ fuel

The oxygen to metal ratio has a strong effect on the physical and chemical properties of thorium-uranium mixed oxide fuel. In this study, the oxygen chemical diffusion was measured in the fuel for an LWR in an attempt to understand the diffusion mechanism.

Experimental procedures

Solid solutions of $(Th, U)O_2$ with thorium concentrations of 1, 3, and 5 per cent, were prepared by co-precipitation, calcination, pressing, and sintering. The density of the specimen with a geometrical size of nearly 8.3 mm in diameter and 1.3 mm in height was above 94 per cent of theoretical. The chemical diffusion coefficient was determined from the weight change of a specimen heated at constant temperature in the temperature range 1,213–1,313 K under an oxidizing or reducing atmosphere.

Figure 3.6.11 shows a schematic of the experimental apparatus. Using a Cahn 2000 microbalance, the weight change was carried out in controlled CO₂, CO/CO₂, and H₂/N₂ atmospheres. Samples were oxidized in the CO₂ or CO/CO₂ atmospheres and reduced in the H₂/N₂ atmosphere. Oxygen pressures were 1.12×10^{-4} , 2.27×10^{-11} , and 1.90×10^{-16} atm for CO₂, CO/CO₂, and H₂/N₂ atmospheres respectively; and were monitored throughout the equilibration with a solid-state oxygen sensor.

Results and discussion

Assuming the oxygen concentration on the specimen surface was constant during heating, the weight change of a cylindrical specimen with size a in radius and $2b$ in height changes with time t according to the following equation:

$$\log \left| \frac{M_{\infty} + M_t}{M} \right| = -0.578 - \left(\frac{2.405^2}{a^2} + \frac{\Pi^2}{4b^2} \right) Dt \quad (1)$$

where D is the chemical diffusion coefficient, M_{∞} and M_t are the final weight change, and the weight change at t , respectively.

Figure 3.6.12 shows a typical weight change, as a function of time, for Th_{0.95}U_{0.05}O_{2+x} fuel heated at 1253 K under a reducing H₂/N₂ atmosphere. The chemical diffusion coefficient of oxygen was obtained from equation (1). Similar runs were carried out on the other specimens of different compositions in the temperature range described above. Figure 3.6.13 shows Arrhenius plots of diffusion coefficients obtained by the least square fitting. They can be represented by the following equations:

$$D = 4.52 \times 10^{-8} \exp\left(-\frac{71.0}{RT}\right) m^2 / s \text{ for } Th_{0.95}U_{0.05}O_2 \quad (2)$$

$$D = 1.42 \times 10^{-7} \exp\left(-\frac{88.3}{RT}\right) m^2 / s \text{ for } Th_{0.97}U_{0.03}O_2 \quad (3)$$

$$D = 2.02 \times 10^{-7} \exp\left(-\frac{99.6}{RT}\right) m^2 / s \text{ for } Th_{0.99}U_{0.01}O_2 \quad (4)$$

The migration energy of oxygen by an interstitial mechanism is calculated to be 88.7 kJ/mol for ThO₂. Activation energies for UO_{2+x} in the range of 73.7–103.5 kJ/mol were calculated based on this interstitial mechanism. Comparing results with calculations, oxygen diffusion for Th_{1-y}U_yO_{2+x} can be interpreted as being through this interstitial mechanism.

Figure 3.6.13 shows the variation of the chemical diffusion coefficients of oxygen with reciprocal temperatures. It appears that the activation energy of Th_{1-y}U_yO_{2+x} decreases slightly with the uranium content y in the range of $0.01 < y < 0.05$. However, other experiments indicate that the activation energy of Th_{1-y}U_yO_{2+x} is independent of the uranium content y . The activation energies of Th_{1-y}U_yO_{2+x} obtained were 93.1 ($y = 0.4$), 66.8 kJ/mol ($y = 0.2$), 108.0 ($y = 0.7$), 112.2 ($y = 0.5$), and 107.1 kJ/mol ($y = 0.3$) [3.6/28]. Thus, it seems that the activation energy is not affected by the uranium content, y .

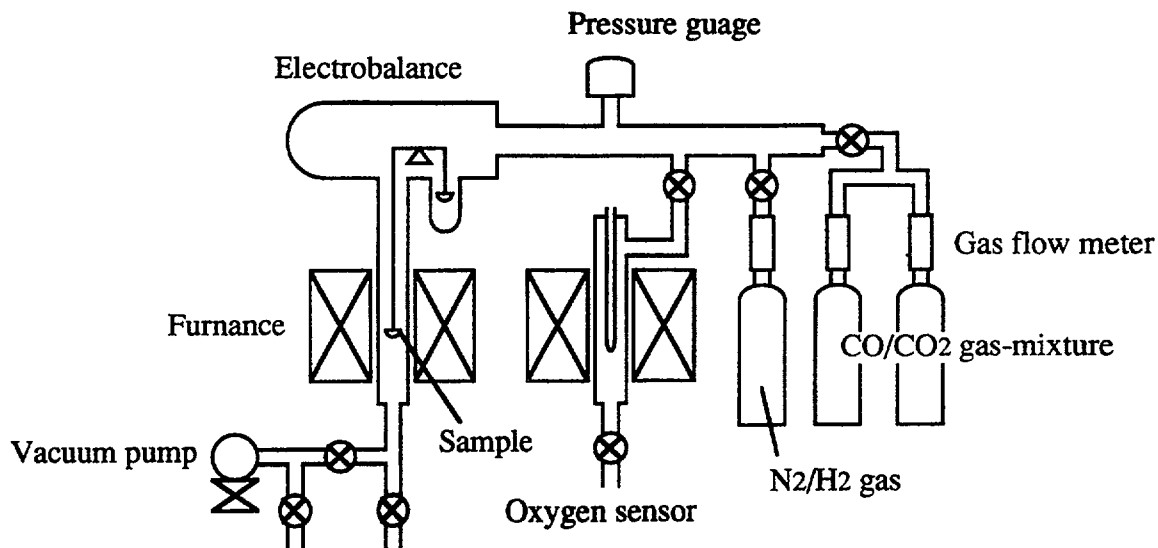

FIG. 3.6.11. Experimental apparatus.

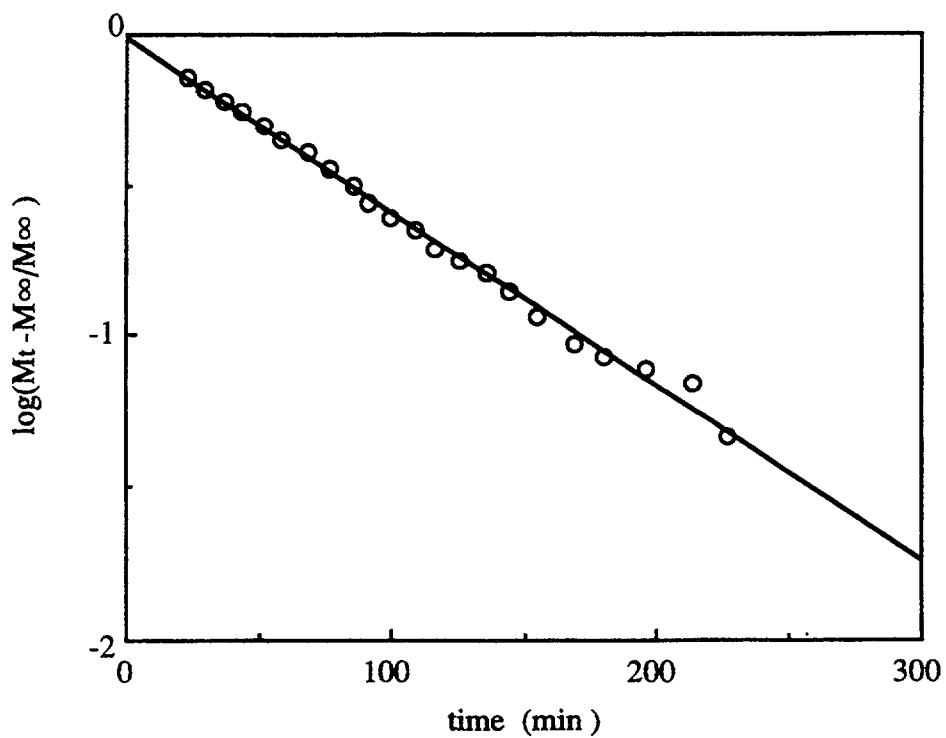

FIG. 3.6.12. Weight change as a function of time, $T = 1253 \text{ K}$, H_2/N_2 gas mixture.

In the oxide (Th, U) O_{2+x}, the chemical diffusion coefficient D can be expressed by the self-diffusion coefficient in the following way:

$$D = \left(\frac{2+x}{2x} \right) \frac{\partial \ln P_{O_2}}{\partial \ln x} \quad (5)$$

where D is the chemical coefficient:

$$\frac{\partial \ln P_{O_2}}{\partial \ln x}$$

and the thermodynamic factor D^* is the self-diffusion coefficient. Assuming that y is proportional to the jump frequency of the interstitial oxygen by the interstitial mechanism, the self-diffusion coefficient is given by:

$$D^* = 2y \left(\frac{x}{2+x} \right) D_i^0 \exp \left(\frac{H_m}{RT} \right) \quad (6)$$

where D_i^0 is constant, and H_m is the migration energy. Introducing equation (6) into equation (5), the chemical diffusion coefficient is written by:

$$D = y \left(\frac{\partial \ln P_{O_2}}{\partial \ln x} \right) D_i^0 \exp \left(\frac{H_m}{RT} \right) \quad (7)$$

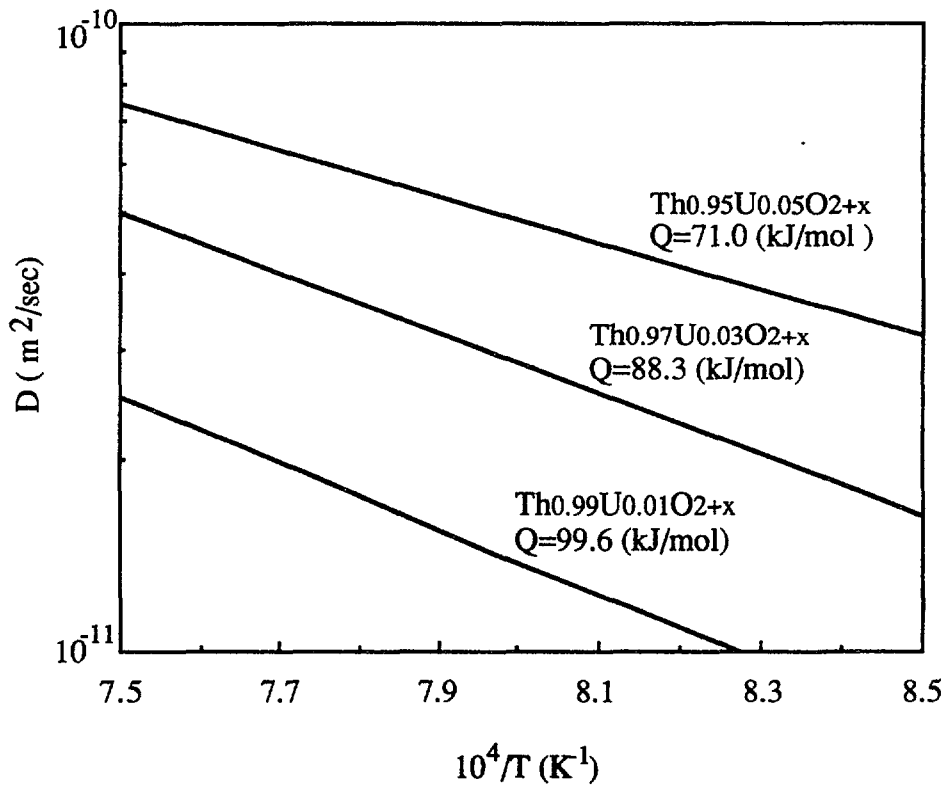

FIG. 3.6.13. Variation of the chemical diffusion coefficients of oxygen with uranium content y .

Using equation (7), the chemical diffusion coefficient can be calculated. The thermo-dynamic factor:

$$\frac{\partial \ln P_{O_2}}{\partial \ln x}$$

is 3 for UO_{2+x} [3.6/29], but approaches 6 with increasing Th content in $(Th, U)O_{2+x}$ [3.6/30]. D_i^0 was obtained by fitting the experimental results to the equation, then the diffusion coefficients, D , at other compositions were calculated. Good agreement between experimental and calculated results was obtained, as shown in Figure 3.6.14.

3.6.3.3. Reprocessing studies for (Th, U) O_2 fuel in Japan

Recent research and development on nuclear fuel cycles in Japan have focused mainly on the Purex process in the U-Pu cycle and little work has been done on the Th-U cycle. The technology developed for the Purex process can be modified for Th-U reprocessing processes such as the thorex process, and seems to have promise for resolving problems.

There have recently been a few studies on reprocessing for the Th-U cycle. However, the chemical behavior of Th and related materials in aqueous media has been investigated since 1980 at a relatively low level, mainly under a Grant-in-Aid for Scientific Research from the Ministry of Education, Science and Culture of the Japanese Government. The down stream chemistry including radioactive waste management for the Th fuel cycle was investigated, and major experimental results were compiled [3.6/31].

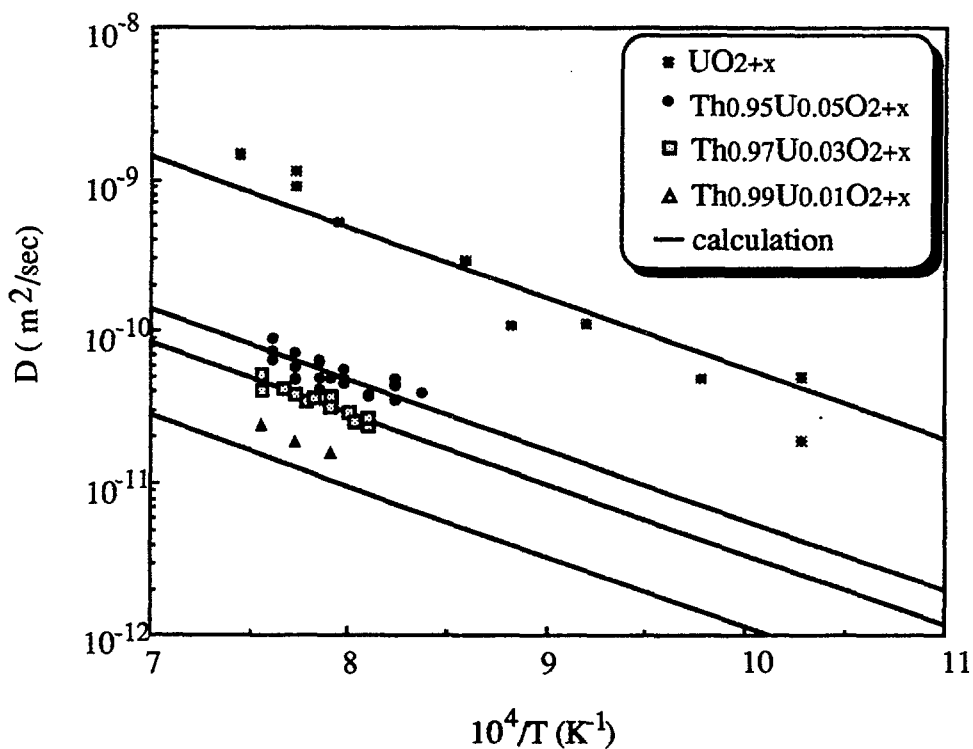

FIG. 3.6.14. Comparison of the chemical diffusion coefficients of oxygen with calculation.

The extraction behavior of Th, U, and some metals, from nitrate solutions, has been investigated using different kinds of acidic organophosphorus extractants in kerosene [3.6/32]. The addition of 1-octanol lowered the distribution ratios, and improved stripping of extracted metals. The distribution ratios of Th and U initially decreased with the nitric acid concentration. However, those of U increased with increases in nitric acid concentration above 1 mol/l. Such a characteristic behavior enhanced the separation factor of U relative to Th.

To obtain basic information concerning the recovery of group elements such as lanthanides and actinides, some extraction systems were investigated. The extraction behavior of Th, Ac, Am and some lanthanides from nitric acid was investigated using bifunctional extractants, and these trivalent cations were found to be extracted as ion pairs. A new extraction system from a water-deficient nitrate medium was developed using a TBP-dodecane solution [3.6/33]. Americium and the lanthanides were highly extractable from a melted salt made of $\text{Ca}(\text{NO}_3)_3 \cdot 4\text{H}_2\text{O}$ and its mixture with $\text{Mg}(\text{NO}_3)_2 \cdot 6\text{H}_2\text{O}$, at 50–80°C. The distribution ratio decreased with an increase in water content. The extraction recovery of Am and lanthanides was accomplished from a simulated waste solution containing nitric acid.

The separation and concentration of several metals were studied using a new separation method, with a supported liquid membrane (SLM), based on liquid-liquid distribution. The transport of U (VI) was achieved through a microporous flat sheet or tubular SLM, impregnating trioctylphosphine oxide from acidic solutions to sodium carbonate solutions [3.6/34]. The carrier-mediated transport of Eu (III) through SLMs containing suitable carriers such as organophosphorus compounds was investigated. Stability of the liquid membrane was much improved by the addition of 1-octanol in the membrane phase and transport of Eu was accomplished [3.6/35]. Europium was transported through the bifunctional organophosphorus extractant from the acidic media into a dilute acidic media and by the combination of two SLM systems. Eu and Am were concentrated by a factor of about 20 [3.6/36].

For the dissolution of ThO_2 spent fuel, hydrofluoric acid was usually added to the reprocessing solution as a catalyst. The effect of fluoride ions on the denitration process of a high-level liquid waste (HLLW), and the separation of Cs and Sr from the waste solution, was investigated [3.6/31]. Denitration of HLLW was performed by the addition of formic acid in the simulated HLLW; the presence of HF below 0.1 mol/l had no effect on the denitration. The structure of the zeolites was stable in HF below 0.1 mol/l, and the distribution coefficients (ml/g) for Cs and Sr were above 10^4 .

Other fundamental experiments were performed with a synthetic hydrous metal oxide ion-exchanger to process HLLW. Ion-exchange properties and thermal stability were also studied with respect to the equilibrium and kinetics. Hydrous tin (IV) oxide was useful to separate actinides from long lived fission products such as ^{137}Cs and ^{90}Sr , while hydrous titanium (IV) oxide and hydrous niobium oxide were suitable to remove gross fission products due to the large cation exchange capacities [3.6/37].

3.6.4. Russian Federation

3.6.4.1. Thorium resources, prospecting and mining

In the former USSR, large scale thorium mining has not been conducted recently, since there has been no significant national use of thorium. However, at the early stages of nuclear power development, not only was a mining industry created but plants were built for

reprocessing and production of nuclear-grade pure metallic thorium. Thorium demand for ^{233}U production can be provided by the following potential sources:

- previously produced thorium residues;
- thorium containing wastes from deposits under exploitation; and
- monazite concentrate.

According to data available at the Enterprises Ministry, there are sufficient quantities of thorium in raw material for the following studies and experimental programs:

- characterization experiments for reactors using thorium;
- development of thorium production, reprocessing and recycling technologies; and
- production of necessary amounts of ^{233}U .

3.6.4.2. *Analysis of reprocessing technologies for ^{235}U - ^{233}U -Th-dioxide fuel and manufacturing of fuel elements and subassemblies (WWER and BN type reactors) manufacture of fuel elements and subassemblies (WWER and BN type reactors)*

Since they have an isomorphous structure, uranium and thorium dioxides can form cubic lattice solid solutions at any proportions. In addition to enhanced radiation resistance, thorium dioxide (ThO_2) has the following advantages compared to the uranium dioxide (UO_2):

- rather low non-stoichiometry, avoidance of oxygen effect on thermal conductivity;
- lower linear thermal expansion coefficient;
- thermal conductivity values for non-irradiated UO_2 and ThO_2 are nearly equal (0.035 and 0.04 W/cmC respectively), but the irradiation in the reactor at 1500C leads to a ThO_2 thermal conductivity excess over that of UO_2 . This results in lower operational temperature values on the ThO_2 fuel pin centerline compared to the UO_2 fuel pin at the same power rating.

The use of a ThO_2+UO_2 fuel composition in the fuel element fabrication for WWER and BN type reactors looks promising. The thorium in the fuel element provides ^{233}U breeding and UO_2 alloys with thorium dioxide. Manufacture of fuel elements will be similar for WWER and BN type reactors in our opinion, but there could be differences in several of the operating conditions, since initial components in the blend would differ.

To increase the NPP safety and fuel element operation reliability, it is advisable to consider a fuel composition using uranium and thorium dioxides as fissile materials and zirconium carbide as a matrix. This permits a significant reduction in the fuel operating temperature and core decay heat levels. It will also probably assure reactor operation in the load following mode due to the high thermal conductivity of the matrix material, zirconium carbide (about 20 W/mC). Zirconium carbide (ZrC), with a carbon content ranging from 7.68 to 11.45 wt%, is a chemically stable composition with a melting point of about 3400 °C. ZrC has a high radiation resistance and a thermal expansion coefficient of about $7 \times 10^{-6} / ^\circ\text{C}$ in the temperature range 20–1700 °C. It does not interact with thorium and uranium dioxides at temperatures below 1400 °C or with steam at temperatures below 600 or 700 °C. A sample heating in an air atmosphere results in a mass growth rate of 0.2 kg/m² per hour.

Considering these data, the following process is proposed for fabricating fuel element slugs from a $\text{ThO}_2+\text{UO}_2+\text{ZrC}$ composition:

- (1) Manufacture by powder metallurgy using zirconium of a given configuration with open, uniformly distributed, porosity required to provide the necessary thermal conductivity value (8 to 10 W/m °C).
- (2) Preparation of a thorium and uranium nitrate solution with a specified content of the different components.
- (3) Repeated impregnation of zirconium carbide slugs by the nitrate solution, with subsequent drying (before impregnation, the working chamber containing the ZrC element is evacuated).
- (4) After the specified levels of thorium and uranium have been reached in the slugs, they are calcinated at a temperature of 1000–1100°C to obtain a ThO_2+UO_2 solid solution. The solid solution formation occurs at the temperature below 1000°C, and ThO_2 and UO_2 do not interact with ZrC up to about 1370°C.

The fuel element and subassembly manufacturing process of this fuel composition does not differ significantly from assembling fuel elements with slugs of ThO_2+UO_2 or uranium dioxide.

3.6.4.3. Reprocessing

Development of this fuel cycle requires additional scientific and economic studies. Physical and chemical properties of the uranium-thorium fuel described above result in definite characteristics for the spent fuel recycle. Changes in isotope composition of the fissile and fertile materials should be evaluated by calculations for various reactor types.

In uranium-thorium fuel, the time for fuel "cooling" before recycle should be determined both by the time necessary for full decay of ^{233}Pa into ^{233}U and, most importantly, by the time required for maximum decay of the comparatively short-lived fission products. A "cooling" time of three years has been adopted for uranium-plutonium fuel from thermal and fast reactors and can be increased by at least a factor of two without significant complications (thorium is a cheap and easily accessible fertile material). In addition to other factors, this provides a decrease of ^{228}Th activity in the spent thorium by a factor of 8. The best procedure for recycling uranium-thorium fuel for thermal and fast reactors uses the so-called water methods. Publications are available on these methods.

The fuel chopping operation should not differ from that for uranium and uranium-plutonium fuel however, because of the low speed of the thorium oxide dissolution process in nitric acid, smaller sized fragments should be used. The fuel should be dissolved in the nitric acid with the addition of at least 0.2 mole of hydrofluoric acid. Even here, the process is slow and would be even slower in the presence of considerable amounts of zirconium carbide.

A method must be found to separate fuel-using catalysts such as cerium or silver in combination with electrochemical processes. Perhaps it would be reasonable to induce alloying with salts or to perform an electrochemical salt melt process at initial stages in the chain of reprocessing. As a result of long and preliminary processes, the fuel solution contains $\text{Th}(\text{NO}_4)$ in amounts of up to 300 g/l for thorium, proportional to the uranium content of the fuel. Currently the following three procedures are possible for further reprocessing:

- (a) Direct uranium extraction using an extractant of low concentration (e.g. triisooamylphosphate) in the diluent without saturated hydrocarbons or in heavy diluent, hexachlorbutadiene. Subsequent thorium extraction is conducted with the same extractant having a higher concentration (about 40 per cent). Due to final purification procedures a purification factor of not less than 10^5 can be expected for fission products.
- (b) Crystallization of most of the thorium nitrate with subsequent extraction, purification, and uranium recovery from the mother liquor. Here, the thorium nitrate cake can be stored for an additional period of several years to assure additional decay of Th228; then thorium can be recycled again as reactor fuel.
- (c) The aim should be joint extraction of uranium, thorium and trace amounts of plutonium, with limited purification of fission products. This can be achieved using a high concentration extractant. Feasibility of this technology is based on the assumption that both uranium and thorium contain ^{228}Th and ^{232}U isotopes producing high radiation fuel levels, comparable to fission product impurities ($k_{\text{purification}}$ is assumed to be 10^3 to 10^4).

The uranium to thorium ratio in the final product can be controlled, both by the corresponding additives at the final stages and by partial thorium removal at the extraction stage. In this case, fuel element manufacture requires remotely controlled processes and equipment. It should be noted that in the first two reprocessing methods, it is advisable to use the uranium for fuel manufacture as soon as possible, within about three weeks after shut down of the reactor, or to additionally purify it before the fuel element manufacturing stage. Three weeks is a rather short time and the ^{232}U decay chain is far from being at equilibrium. Daughter products of this decay chain determine the increased exposure dose rate.

Obviously, thorium fuel from fast reactor blankets can be reprocessed differently, since ^{233}U with considerably less ^{232}U content (2–5 ppm) is formed. It can be used for new reactor startup after extraction performed at a high purification coefficient. Plutonium-thorium fuel could be similarly reprocessed. Where complete separation of the final products is preferred, more effective separation can be obtained using the generation of various valence forms of plutonium and by electrochemical or reducing reextraction methods. Handling high and medium activity uranium-thorium fuel wastes, especially when switching to a ^{233}U -Th cycle, is simplified by the absence of transuranic elements. However, it requires attention to the presence of the ^{231}Pa isotope. This isotope should probably be extracted, perhaps even at the beginning of the process, and returned to the LMFR fuel for transmutation.

The refined substances of the extraction are practically salt free solutions, permitting evaporation with water and return of the nitric acid to the basic cycle. They do not produce greater difficulties for waste vitrification due to their compositions and can be a source of ^{137}Cs , ^{90}Sr and ^{99}Tc isotopes needed for the national economy.

3.6.5. USA

An abundant supply of thorium is necessary to implement thorium based fuel on a scale significantly supplementing uranium resources. Thorium, which is essentially 100 per cent ^{232}Th , is three times more abundant in the earth's crust than uranium. This reflects differences in the half-lives of ^{232}Th (1.4×10^{10} years) and ^{238}U (4.5×10^9 years). However, recoverable resources of thorium are quite uncertain, because unlike uranium, the demand and exploration for thorium has been limited. For the same energy output, the demand for thorium should be about 20 per cent of the demand for uranium, because in an LWR economy only about 20 per cent of the mined uranium ore is actually used in the reactor. With no recycle, the thorium, having no fissile component, is used strictly as a replacement for ^{238}U in-core. Recycle would

reduce the thorium demand to perhaps 5–7 per cent of the uranium demand for a reactor lifetime of 40 years. This leads to the conclusion that thorium resource considerations would not limit use of the thorium fuel cycle for any reasonable projection of LWR installed capacity.

The USA is believed to have considerable thorium with major deposits in California, Colorado, Idaho, Montana, New Mexico, and Wyoming, but there is no current interest in exploration or mining this resource due to lack of demand.

Considerable experience has accumulated in the USA in thorium fuel fabrication. For the Fort St. Vrain reactor, 2448 hexagonal graphite fuel elements, 7.1 million fuel compacts and 26 000 kg of fissile and fertile material in TRISO-coated fuel particles were produced. This included almost 25 000 kg of thorium and performance of the fuel exceeded predictions. It was irradiated at temperatures greater than 1300°C to a maximum burnup in the fissile particles of 16 per cent fissions in initial metal atoms to a maximum fast neutron fluence of 4.5×10^{25} n/m² with no evidence of significant coating failure. Over 50 t of thorium fuel in ceramic form, clad in Zircaloy, was also manufactured for the Shippingport LWBR core. No special problems were encountered during fuel manufacture. However, US regulations governing MPC limits on thorium in air have been dramatically tightened since this fuel was produced and allowable limits have been reduced by a factor of 20. Thus, renewed manufacture of thorium fuel would increase in cost due to tight health physics control and monitoring. Finally, no thorium reprocessing of any consequence has been undertaken in the USA to date.

REFERENCES

- [3.6/1] KFA/SIEMENS-KWU/NUKEM/NUCLEBRAS, "Program of Research and Development on the Thorium Utilization in PWR's", Final Report 1979–1988, Jül-Spez. 488 (1988).
- [3.6/2] HUSCHKA, H., VYGEN, P., "Coated Fuel Particles: Requirements and Status of Fabrication Technology", Nuclear Technology, **35** (1977).
- [3.6/3] ZIMMER, E., BARNERT, E., NAEFE, P., RINGEL, H.D., "Equipment for remote production of coated particles", Proceedings of the 28th Conf. On Remote Systems Technology (1980).
- [3.6/4] ZIMMER, E., NAEFE, P., RINGEL, H., "Aqueous chemical processes for the preparation of HTR fuel kernels", Radio Chimica Acta **25** (1972).
- [3.6/5] ZIMMER, E., GANGULY, C., BORCHARDT, J., LANGEN, H., "Advanced method for fabrication of UO₂ and Mox fuel pellets", Journal of Nuclear Materials (1987).
- [3.6/6] GANGULY, C., LANGEN, H., ZIMMER, E., MERZ, E., "Sol-Gel microsphere pelletization process for fabrication of high-density ThO₂ — 2% UO₂ Fuel for Advanced PHWR's", Nuclear Technology, Vol. **73** (1986).
- [3.6/7] ZIMMER, E., GANGULY, C., "Reprocessing and re-fabrication of Th-based Fuel", IAEA- T1-TC-566-III/3.
- [3.6/8] KFA-Jülich, "German HTR Fuel under Normal Operating and under Accident Conditions", internal report (1993).
- [3.6/9] FUMOTO, ZIMMER, E., KIYOSE, R., MERZ, E., "A study of pulse columns for Th-Fuel reprocessing", Univers. of Tokyo/KFA Jülich, (Part I und II) (1987).
- [3.6/1] NAKASHIMA, T., ZIMMER, E., "Die Verteilung von Th (NO₃)₄, UO₂ (NO₃)₂ and HNO₃ zwischen wässriger Phase und organischer Tributylphosphat-Phase", KFA-Jülich, Jül-1920 (1984).

- [3.6/11] ZIMMER, E., MERZ, E., "Dissolution of Th-U-mixed-oxides in concentrated nitric acid", *Journal of Nuclear Materials* (1984).
- [3.6/12] NAKASHIMA, T., ZIMMER, E., "Hydrolysis of Th (NO₃)₄ and its extractability by TBP", *Radio Chimica Acta* **37** (1984).
- [3.6/13] ZIMMER, E., BORCHARDT, J., "Crud formation in the Purex and Thorex processes", *Nuclear Technology*, Vol 75 (1986).
- [3.6/14] ZIMMER, E., BORCHARDT, J., "Thorex Process Studies", *Dechema*, Vol 1 (1986).
- [3.6/15] FUMOTO, H., SUZUKI, A., KIYOSE, R., ZIMMER, E., MERZ, E., "Droplet diameters and axial mixing in pulse columns in the comparison of the aqueous to organic continuous mode of operation", *Nuclear Technology*, Vol 77 (1987).
- [3.6/16] GANGULY, C., "Development of thorium based fuels for water cooled reactor", *Proceedings of the Indo-Japan Seminar on Thorium Utilization*, December 1-13, Bombay (1990) 77.
- [3.6/17] VAIDYA, V.N., SOOD, D.D., "Gelation studies for preparation of thoria and thoria-10% urania microspheres using internal gelation process", *ibid*, p.86.
- [3.6/18] FUKUDA, K., et al., "Research and development of HTGR fuel at JAERI", *Advanced fuel technology and performance (proc. conf. Vienna, 1989)* IAEA-TECDOC-577, Vienna (1990) 83.
- [3.6/19] YAMAGISHI, S., TAKAHASHI, Y., "Further Study on Sintering Behavior of Sol-gel ThO₂ Microspheres", *J.Nucl. Mater.*, 182 (1991) 195.
- [3.6/20] YAMAGISHI, S., TAKAHASHI, Y., "Effect of heating atmosphere on densification of sol-gel (Th,U)O₂ microspheres", *J. Nucl. Mater.*, 207 (1993) 255.
- [3.6/21] YAMAGISHI, S., TAKAHASHI, Y., "Preparation of high density (Th,U)O₂ pellets by sol-gel microsphere pelletization at 1300°C air sintering", *J. Nucl. Mater.*, 217 (1994) 127.
- [3.6/22] YAMAMOTO T., et al., "Hydrogen absorption properties of U-Th-Ti-Zr alloys", *J. Alloys Compds.* 213/214 (1994) 467.
- [3.6/23] YAMAMOTO, T., et al., "Hydrogen absorption properties of U-Th-Zr and U-Th-Ti-Zr alloys", *Sci. Rep. RITU*, A40 (1994).
- [3.6/24] YAMAMOTO, T., et al., "Development of new reactor fuel materials: hydrogen absorption properties of U-Th-Zr and U-Th-Ti-Zr alloys", *J. Nucl. Sci. Technol.*, 32 (1995) 260.
- [3.6/25] AKABORI, M., FUKUDA, K., "Internal release of metallic fission products in (Th,U)O₂", *J. Nucl. Mater.*, 183 (1991) 70.
- [3.6/26] AKABORI, M., FUKUDA, K., "Release behavior of cesium in irradiated (Th,U)O₂", *J.Nucl. Mater.*, 186 (1991) 47.
- [3.6/27] SHIRATORI, T., et al., "Irradiation performance and integrity of thorium oxide based coated particle fuels at high burnups", *JAERI-M 90-144* (1990).
- [3.6/28] FURUYA, H., "Chemical diffusion of constituent elements in the thorium- uranium mixed oxide fuel", *Proc. Indo-Japan Seminar on Thorium Utilization* (1990) 156.
- [3.6/29] MATSUI, T., NAITO, K., "Oxygen potentials of (Th,U)O₂ and (Th_{1-y},U_y)O_{2+x}", *J. Nucl. Mater.*, 132 (1985) 212.
- [3.6.30] UGAJIN, M., "Oxygen potentials of (Th,U)O₂ solid solutions", *J. Nucl. Mater.* 110 (1982) 140.
- [3.6/31] SUZUKI, S., et al. (Ed), "Chemical Aspects of Down Stream for Thorium Fuel Cycles", *At. Energy Soc. Japan* (1987).
- [3.6/32] AKIBA, K., et al., "Solvent extraction of thorium, uranium and some metals from nitrate solution with organophosphinic acid", *Proc. Symp. Solvent Extr.* (1991) 181.

- [3.6/33] MITSUGASHIRA, S., et al., "Extraction of Am and lanthanides with tributyl phosphate from water deficient nitrate media", *J. Alloys and Compounds*, 213/214 (1994) 347.
- [3.6/34] AKIBA, K., HASHIMOTO, H., "Uranium (VI) transport through supported membrane", *Anal. Sci.*, 2 (1986) 541.
- [3.6/35] NAKAMURA, S., AKIBA, K., "Transport of Eu (III) through supported liquid membrane containing dodecylphosphoric acid", *Sep. Sci. Technol.*, 24 (1989) 673.
- [3.6/36] NAKAMURA, S., AKIBA, K., "Transport of Eu (III) through supported liquid membrane containing dihexyl-N, N-diethylcarbamoylmethylphosphate", *Sep. Sci. Technol.*, 24 (1989/90) 1317.
- [3.6/37] INOUE, Y., YAMAZAKI, H., "Ion-exchange property and thermal stability of hydrous metal oxide ion changers", *J. Nucl. Sci. Technol.*, 24 (1978) 462.

3.7. THORIUM USE IN NEUTRON SOURCE DRIVEN SYSTEMS

3.7.1. France

Accelerator driven systems (ADS), consisting of a subcritical blanket and a proton accelerator supplying this blanket with supplementary neutrons [3.7/1, 3.7/2] can be considered an alternative to other fission reactor concepts. Analysis of the neutronics of ADS [3.7.3] shows that benefits stem mainly from an increase in neutron multiplication and to subcritical operation, which prevents transients without scram. The neutron multiplication effect gained from spallation in the target depends on the fission energy and thermal efficiency of the blanket. For example, fast spectrum blankets gain an advantage of about 20–30 per cent in the number of neutrons per fission, compared to thermal spectrum blankets.

ADS can increase the neutron surplus available for the LLFP incineration. This is more important for fuel cycles with reduced neutron surplus production, that is, thermal reactors. This potential is related to ADS economics, which depends on the fraction of energy required to drive the accelerator. ADS deterministic safety (self-protection against reactivity accidents) is not sensitive to the relatively low delayed neutron fraction of the thorium based fuel. The thorium cycle potential is higher in ADS for LLFP-incineration and it has potential to enhance deterministic safety features of the thorium based fuel cycle.

3.7.2. Germany

Synthetic fuel production has been proposed both for accelerator driven systems and for fusion reactor blankets. A study group at the Oak Ridge National Laboratory made an assessment of the accelerator breeder as well as those by KFA, Jülich, and KfK, Karlsruhe. In this concept, protons are accelerated to an energy level of 1 GeV and directed onto a heavy metal target producing a cascade of secondary particles and neutrons. The neutrons are absorbed in a surrounding thorium blanket, thus breeding ^{233}U . The production of neutrons is improved by fission in the thorium and in the bred material. A beam of 300 mA produces \cong 2.8 kg of ^{233}U per day [3.7/4].

Recently, an accelerator-driven system operating with thermal neutrons and liquid fuel (lead-actinide-suspension) was proposed by the Research Center KFA-Jülich. Here, the goal is a self-sufficient system breeding its own fuel and producing a surplus of electrical energy. Operating the device at a neutron multiplication factor $K_{\text{eff}}=0.9$ and at a beam current $I_{\text{beam}}=25$ mA ($E_p=1.6$ GeV), allows a net system efficiency $\eta_{\text{tot}}=0.30$, producing a surplus of fissile material (^{233}U) of about 6 per cent per year [3.7/5].

These production facilities require major development and final reference plant size is not yet available. To assess their potential for uranium conservation under an assumed world strategy for energy production, a standardized size has been assumed producing 5.0 kg of ^{233}U per day. It is referred to here as the synthetic fuel production machine (SFPM).

3.7.3. India

Fissile material is absent in naturally occurring thorium. This inherent disadvantage makes the use of thorium for power generation less easy and straightforward than use of natural uranium. Power can be extracted from sub-critical assemblies if an external source of neutrons is supplied.

Historically, work on exploiting neutrons from processes other than fission to derive fissile materials usable in a nuclear reactor was started at least 30 years ago. Initially it was thought that irradiating thorium with an external source of neutrons and then recovering the ^{233}U produced, would be the ideal way to convert thorium into ^{233}U . Now a school of thought maintains there are greater benefits in using the external source of neutrons to drive a subcritical thorium-fueled reactor. Such an approach has many advantages. One of the most attractive is the elimination of dependence on fuel element composition to sustain reactor criticality and to achieve very high fuel burnup. Fabrication cost is an important component in the economics of the fuel cycle and fuel fabrication is expensive. Once the link between fuel element composition and reactor criticality is eliminated, the discharge burnup can be as high as the fuel integrity will allow.

Although it is theoretically feasible to start with fuel containing thorium alone, practical considerations make this system unattractive. If the reactivity swing of the core that is to be mediated by the external neutron source is very large it should be possible to regulate the strength of the neutron source over a wide range. Detailed analysis is needed to optimize the initial subcriticality of the reactor and the range of neutron source strength required. But it can be assumed that initially having some fissile material in the thorium fuel is better. The initial fissile enrichment, the final discharge burnup of the fuel, and the neutron source must be optimized with realistic constraints.

The type of neutron source can be chosen depending on the available technology but it is not essential that the neutron source be external. An advanced heavy water reactor is being designed in India with a major part of the core subcritical and a limited number of booster seed regions. The seed regions will need a fairly high concentration of fissile material. These can be ^{233}U , enriched uranium or plutonium. Excess neutrons from these seed regions will drive the bulk of the reactor core, which can be thorium fueled. Engineering considerations will dictate the minimum fissile material concentration present in these so called blanket assemblies to ensure that power distribution in the core is within an acceptable range over the life time of the core loading. On-line fuel loading in heavy water reactors makes it possible to meet the required fueling rate for different reactor regions.

The external source of neutrons can be from a fusion reactor. Nuclear fusion is recognized as a "neutron-rich" process, while nuclear fission is an "energy-rich" process. It is possible to combine a fusion reactor and a subcritical fission reactor such that the neutrons produced in the fusion reaction support the fission reactor. In turn, if necessary, the fission reactor can supplement the energy released in the fusion reaction. Considering the need to maintain very high temperatures for a sustained fusion reaction, it is widely recognized that it is easier to realize a fusion reactor if it is not expected to be a net energy producer. Thus a symbiosis between a net energy consuming fusion reactor and a net neutron-deficient fission reactor is possible and comprises a net energy producing system suited to a thorium fuel cycle.

Yet another source of neutrons was originally proposed thirty years ago as part of an accelerator based fissile material factory. This employs a neutron source in which a beam of high-energy protons impinges on a target of lead or bismuth. High-energy neutrons produced from the spallation reaction between the high-energy proton and a target material like bismuth or lead, can be directed to a subcritical reactor in which thorium is the major fuel. The energy of the neutrons emanating from the spallation reaction is high enough to cause fission of the thorium nuclide itself. These neutrons can be multiplied by using a material like beryllium with a reasonably high (n, 2n) reaction.

The important point is not the specific type of neutron source used in the source-driven reactor rather it is that the thorium-fueled core need not be capable of maintaining a self-sustaining chain reaction. The possibility of using an external source of neutrons to maintain the reaction opens the possibility of achieving very high discharge burnup of thorium fuel.

Source driven systems can be built around both thorium and uranium however, thorium systems have a significant advantage over uranium. As burnup proceeds, subcriticality of the system increases and power decreases. The power level can be maintained either by increasing the source strength or reducing the level of subcriticality by removing control rods or their equivalent. Since it is more difficult to change the source strength, the normal option would maintain the same level of subcriticality. The advantages of thorium systems arise here, for the loss of reactivity with burnup in thorium fuel is much less than in uranium.

Another version of a source driven reactor is the fission-fusion hybrid. It is proposed to have fusion reactions set off by laser plasma interaction in small micro-pellets (beam method). The D-T reaction in these pellets will yield neutrons, which will enter the subcritical assembly inside a ring of these micro pellets. Energy production will result from this assembly, with the fusion part only supplying neutrons to sustain the chain reaction. The advantage of this method is that the strength of the beam can be changed to adjust the reactor power. The position of the beam, as targeted into the reactor, can be adjusted to get the desired power distribution. From an engineering standpoint, the beam lends itself to the requirement of injecting neutrons into the interior of the subcritical assembly better than fusion plasma, which depends on inertial confinement.

Even though not strictly a source driven system, a source of neutrons interacting with a thorium or ^{238}U blanket can be used as fissile factories to produce ^{233}U for use in normal reactors. But ^{233}U production is more advantageous than the production of ^{239}Pu from a ^{238}U blanket because if ^{233}U was used as makeup fuel in a thorium ^{233}U SSET system, very high fuel utilization values are possible. For example, in a fusion breeder of 1000 MW(e), it can produce about 3800 kg of $^{233}\text{U}/\text{a}$. If this quantity of ^{233}U could support an installed capacity of N GW(e) running on the thorium- ^{233}U cycle, the "support ratio" is defined as N. Table 3.7.1 shows the support ratio for different values of thorium discharge burnup.

The tremendous multiplier effect of the thorium cycle seen here is not possible with the uranium cycle in thermal reactors.

TABLE 3.7.1. SUPPORT RATIO OF FISSION REACTOR TO FUSION BREEDER

^{233}U Content	Fissile inventory	Discharge burnup	Fissile inventory	Makeup $^{233}\text{U}/\text{kg}$	Support ratio
(%)	GW(e)	MWd/t	ratio	a/GW(e)	N GW(e)
1.5	2.65	12500	0.988	11.7	326
1.55	2.74	16900	0.963	27.1	140
1.6	2.82	20700	0.936	39.2	97
1.65	2.91	24100	0.909	49.3	77
1.7	3.00	27200	0.882	57.9	66
1.75	3.09	30000	0.857	65.5	58
1.8	3.18	32700	0.833	72.4	52
1.85	3.27	35100	0.810	78.5	48

3.7.4. Japan

Accelerator molten-salt breeders (AMSB)

To solve global energy problems in the next century, an effective fission industry should be developed. This will not be achieved by the "fission breeding power station" concept, such as the LMFBR nor the MSBR [molten-salt breeder reactor] proposed by ORNL. The latter is impractical due to complex structure and maintenance, weak breeding performance; and inflexible power size but, an economical breeding fuel cycle should be established. Alternatively, synergetic systems could be designed to couple fission spallation, and a fissile breeder, depending on neutrons generated by fusion or spallation reactions. Overall, the most significant technological issues are:

- Safety;
- radioactive-waste;
- nuclear proliferation and terrorism; and
- economy or worldwide applicability.

The thorium fuel-cycle has advantages in solving the problems of radioactive-waste, plutonium production, and non-proliferation, due to the limited production of trans-U-elements and high gamma activity of ^{233}U . Regarding safety, the thorium molten-salt (fluoride) fission power stations will not have severe accidents and subcritical spallation fissile breeders (accelerator breeders) will also have advantages in safety.

The accelerator molten-salt breeder (AMSB) was invented in 1980 [3.7/6], establishing the Th breeding fuel-cycle with this system (FUJI-series) named THORIMS-NES (thorium molten-salt nuclear energy synergetics) [3.7/7]. Other possible candidates for AMSB, the inertial-confined fusion hybrid molten-salt breeder (IHMSB) [3.7/8] and impact fusion molten-salt breeder (IFMSB) were also proposed [3.7/9], although the AMSB appears the most sound and promising concept.

The AMSB design is based on the "single-fluid type molten salt target/blanket"; the size of the target salt bath is 4–4.5 m in diameter, and 5–6 m in depth. The proton beam (1 GeV, 300 mA) is directly injected in an off-centered position near the bottom of the salt-vortex, reducing neutron leakage and improving heat dissipation. Some design parameters have been widely varied, but a typical salt composition is $\text{LiF-BeF}_2\text{-ThF}_4\text{-(}^{233}\text{UF)}_4 = 64\text{-}18\text{-}17.5\text{-}0.5$ mol%, which can be used directly as a fuel-salt of the MSR (Fig. 3.7.1). This concept has essentially no feasibility problems with respect to:

- material radiation-damage;
- heat removal;
- neutron-shielding;
- continuous operation; and
- spallation-product chemistry.

However, replacing the present U-Pu fuel-cycle with thorium is not easy. This problem can be solved more easily by the modification of THORIMS-NES, enabling nearly complete elimination of world Pu stocks from dismantled Pu weapons and accumulated Pu in spent solid-fuels in present and future civil reactors. A new approach consisting of the following three plans is recommended:

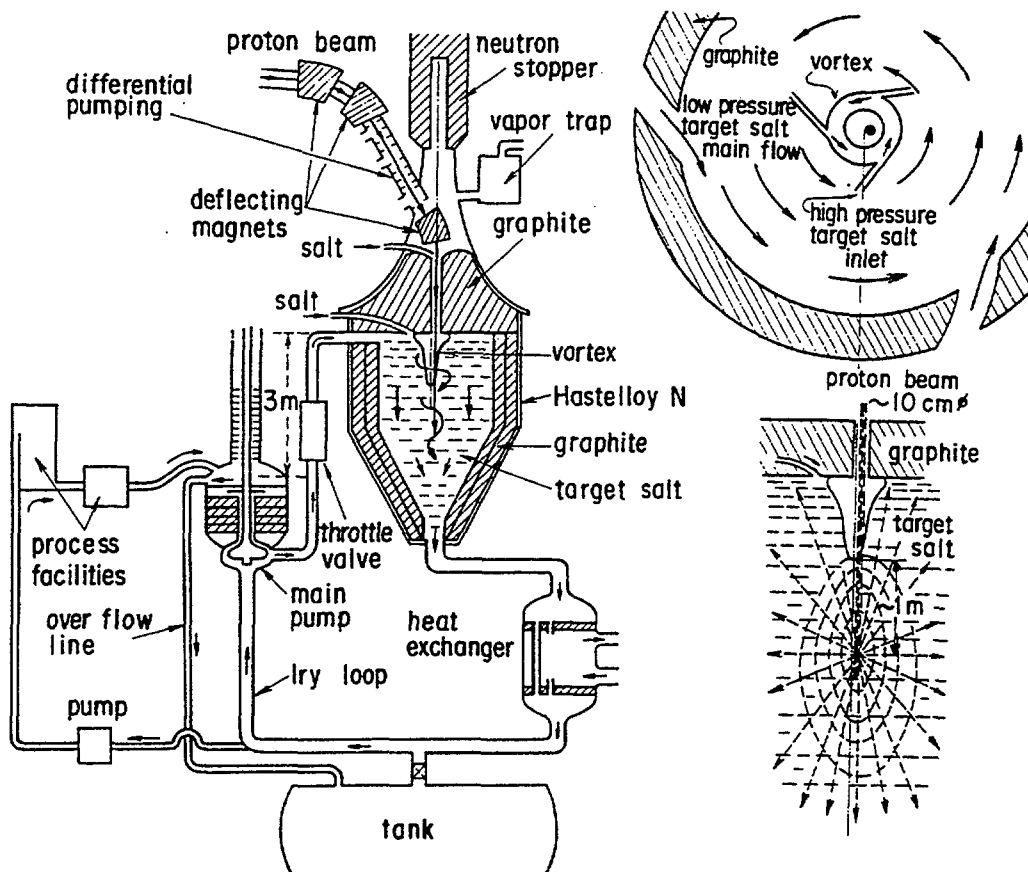

FIG. 3.7.1. Schematic figure of molten-salt target/blanket system of accelerator molten-salt breeder (AMSB).

(I) D-plan: Pu (and TRU) separation by dry-process from spent solid-fuels.

The new dry-process by molten-fluoride technology should be developed to improve economy and diversion resistance and to supply fluoride salts for F- and A-plans. France, The Russian Federation, etc. examined the technological basis of this concept.

(II) F-plan: Pu-burning and ^{233}U -production by MSR [FUJI-Pu].

The most rational safe technology for effective Pu-incineration will be application of the Th-MSR. It consists of one simple system: The FUJI-Pu has been studied verifying rapid and continuous Pu-burning by the periodical isolation of ^{233}U , which is produced for the next Th-U cycle power stations [3.7/10].

(III) A-plan: Pu-burning and ^{233}U -production by the AMSB-Pu.

In parallel with the F-plan, spallation/fission reactions in the AMSB will be applicable for the same purpose given under the F-plan.

A new design has been developed, the AMSB-Pu, in which performance varies widely, depending on the salt composition (typical: ${}^7\text{LiF}\text{-BeF}_2\text{-ThF}_4\text{-UF}_2\text{-}^{233}\text{U}\text{-}^{239}\text{PuF}_3 = 64\text{-}18\text{-}[18\text{-}(X+Y)]\text{-}X\text{-}Y$ mol%). The radiation resistance life of the reflector graphite and the accumulation of spallation and fission products, etc., restrict the size of the salt-bath. The choice of X and Y = 0.5 mol% will be convenient in the initial stage due to the mild thermal (electric-power self-sustaining) and reactor chemical conditions, producing 0.75 tons of $^{233}\text{U}/\text{a}$ in a doubling-time of about 4 years. The production of ^{233}U is 2-3 times greater than the

incinerated rate of Pu. At maturity, the performance can be significantly improved, resulting in an excess-electricity production of about 1–2 GW(e), decreasing fissile production costs. However, the AMSB probably will not be a popular power station for utility purposes. The accuracy of these theoretical estimates is not high, and an irradiation experiment on a large frozen salt target is required.

Applying these plans, these efforts would culminate in the gradual preparation of a real THORIMS-NES. A more plausible scenario would be opening the thorium-era by elimination of Pu by the middle of the next century; depending on application of the D-, F- and A-plans to U-Pu power systems early in the next century.

REFERENCES

- [3.7/1] SALVATORES, M., SLESSAREV, I., UEMATSU, M., “Global physics approach to transmutation of radioactive nuclei”, NSE, 116, 1-18 (1994).
- [3.7/2] CARMINATI, F., et al., “An energy amplifier for cleaner and inexhaustible nuclear energy production driven by a particle beam accelerator”, CERN/AT/93-47 (ET) (1994).
- [3.7/3] TAKAHASHI, H., RIEF, H., “Critical review of accelerator-based transmutation systems”, OECD-Nuclear Energy Specialists Meeting, Würenlingen, March 24–26 (1992).
- [3.7/4] KUGELER, K., “Physical and technical aspects of a spallation reactor”, Specialists Meeting on Accelerator-driven Transmutation Technology for Radwaste and other Applications, June 24–28, Stockholm (1991).
- 3.7/5] LIZANA, P., PHLIPPEN, P.W., “Unterkritische Systeme in der Nukleartechnik: Energieproduktion, Transmutation, Spaltstoffherzeugung”, Forschungszentrum Jülich, (to be published).
- [3.7/6] FURUKAWA, K., et al., “Single-fluid type accelerator molten-salt breeder concept”, J. Nucl. Sci. Tech., 18 (1981) 79.
- [3.7/7] FURUKAWA, K., et al., “Summary report: thorium molten-salt nuclear energy synergetics”, J.Nucl. Sci. Tech., 27 (1990) 1157.
- [3.7/8] FURUKAWA, K., “Symbiotic molten-salt systems coupled with accelerator molten salt breeder or inertial-confined fusion hybrid molten salt breeder and their composition”, Atomkern. Kerntech., 44 (1984) 42.
- [3.7/9] IKUTA, K., FURUKAWA, K., “Impact fusion molten-salt breeder (IFMSB)”, Proc. Joint Int. Sympo. Molten Salts, Electro-chem. Soc., 87-7 (1987) p.906–915.
- [3.7/10] FURUKAWA, K., et al., “Accelerator molten-salt breeding and ²³³U-production”, Proc. Emerging Nuclear Energy Systems - ICENES'93 (YASUDA H., Ed.) World Science, Singapore (1994) 429.

3.8. TOXICITY AND RELATED PROBLEMS

3.8.0. General: Definition of the toxicity of radioactive waste [3.8/1]

A comparison of the toxicity of the waste from different fuel cycles depends on the current definition of the hazard potential of several isotopes by national and international authorities. These values have changed several times during the last few decades. The maximum allowable concentrations of the isotopes in drinking water (ingestion) formerly were the common basis for calculating waste toxicity. However, current recommendations define maximum values for the annual limit on intake (ALI) of all types. The threshold values, defined in 1971 by the Code of Federal Regulations (10CFR20), were based on an allowable dose of 5 mSv/a. In ICRP-30 (1981), a new assessment of the actinide isotopes was published with a reduction in threshold values for intake by about one order of magnitude.

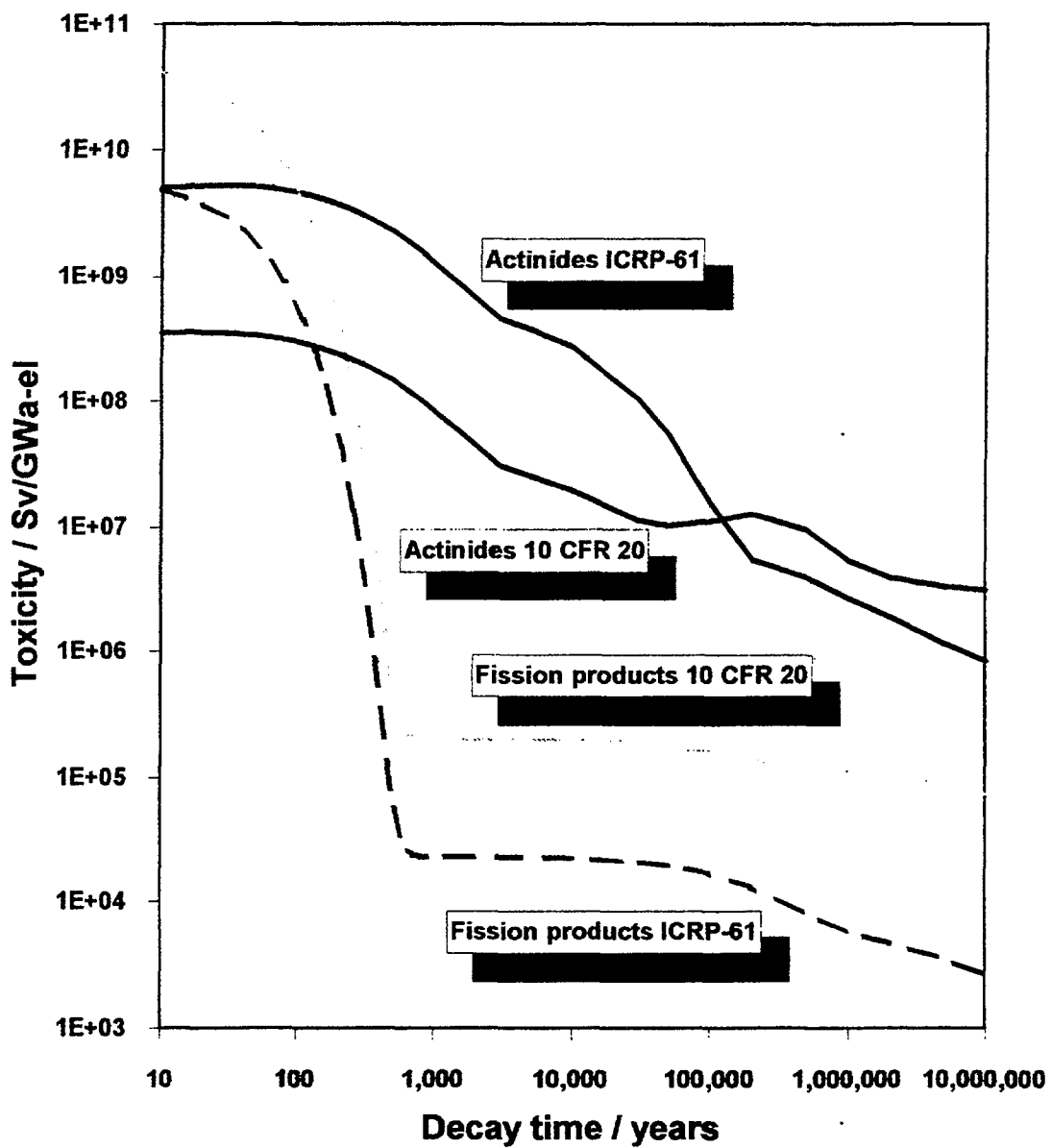

FIG. 3.8.1. Toxicity of PWR-U-fuel using different ALI-values.

Simultaneously, the allowable value of ^{90}Sr was increased. Further reviews were performed in 1988 and 1991. Current recommendations are based on ICRP-60 and ICRP-61 of 1991. Table 3.8.1 gives a survey of the admissible dose per year ALI-values for ingestion, showing changes in value over time according to both ICRP-61 and 10CFR20. Figure 3.8.1. shows a comparison of time dependency of the toxicity of the actinides and fission products according to ICRP-61 on the one hand and to 10 CFR 20 on the other. As a consequence of the reassessment of threshold values, the actinides now determine the toxicity from the very beginning of waste disposal.

TABLE 3.8.1. COMPARISON OF ALI-VALUES

		ICRP-61	ICRP-30	ICRP-30	10 CFR 20
Year		1991	1980	Part 4 1988	1971
Nuclide	Half-life	Bq/Sv	Bq/Sv	Bq/Sv	Bq/Sv
^{90}Sr	28.5 a	3.0E+7	2.0E+7	-	2.2E+6
^{135}Cs	2E+6 a	5.0E+8	6.0E+8	-	7.4E+8
^{137}Cs	30.17 a	5.0E+7	8.0E+7	-	1.5E+8
^{99}O	2.1E+5 a	1.5E+9	2.0E+9	-	1.5E+9
^{129}I	1.57E+7 a	1.0E+7	4.0E+6	-	4.4E+5
^{210}Pb	22.3 a	1.0E+6	4.0E+5	-	7.4E+5
^{210}Po	138.38 d	4.5E+6	2.0E+6	-	5.2E+6
^{226}Pa	1600 a	4.5E+6	1.4E+6	-	2.2E+5
^{233}U	1.59E+5 a	3.5E+7	8.0E+6	-	2.2E+8
^{234}U	2.45E+5 a	3.5E+7	8.0E+6	-	2.2E+8
^{235}U	7.04E+8 a	3.5E+7	1.0E+7	-	2.2E+8
^{236}U	2.342E+8 a	3.5E+7	1.0E+7	-	2.2E+8
^{238}U	4.47E+9 a	4.0E+7	1.0E+7	-	3.0E+8
^{237}Np	2.14E+6 a	1.5E+6	6.0E+4	4.0E+5	2.2E+7
^{238}Pu	87.74 a	2.0E+6	6.0E+6	6.0E+5	3.7E+7
^{239}Pu	2.41E+4 a	2.0E+6	4.0E+6	6.0E+5	3.7E+7
^{240}Pu	6550 a	2.0E+6	4.0E+6	6.0E+5	3.7E+7
^{241}Pu	14.4 a	1.0E+8	2.0E+8	2.0E+7	1.5E+9
^{242}Pu	3.76E+5 a	2.0E+6	6.0E+6	6.0E+5	3.7E+7
^{241}Am	432.6 a	1.5E+6	1.0E+6	6.0E+5	3.0E+7
^{243}Am	7370 a	1.5E+6	1.0E+6	6.0E+5	3.0E+7
^{243}Cm	28.5 a	2.5E+6	1.4E+6	8.0E+5	3.7E+7
^{244}Cm	1811 a	3.0E+6	1.8E+6	1.0E+6	5.2E+7

3.8.1. France

3.8.1.1. Fuel inventory toxicity source

Relative inventory risks for the LWR with a closed fuel cycle and the fast reactor (FR) with uranium and thorium fuel cycles are presented in Table 3.8.2. This risk was defined as 1, for LWR uranium fuel, for long (L) and short (S) intervals of time averaging [3.8/2].

TABLE 3.8.2. THE RELATIVE INVENTORY OF TIME AVERAGE TOXICITIES AT EQUILIBRIUM (CLOSED FUEL CYCLES)

Fluxes: $F=10^{14}$ n/cm² s in the LWR, $F=10^{15}$ n/cm² s in FR

Reactor and fuel types	(S/L)*
LWR (loading: 60% ²³⁵ U, 40% ²³⁸ U)	1/1
LWR (loading: 10% ²³³ U, 90% ²³² Th)	0.08/1.2
FR (loading: 100% ²³⁸ U)	3.5/1.2
FR (loading: 100% ²³² Th)	0.08/1.8

* S/L - Short (10^2 to 10^4 years) and Long (10^2 to 10^6 years) time intervals of averaging

It can be seen that Th-based fuel cycle reactors, with either a fast or thermal spectrum, have a definite advantage, compared to uranium-based reactors, for the short time interval. For the longer interval this advantage disappears because of the long term high toxicity of the thorium daughters, ²³³U, and ²³¹Pa.

3.8.1.2. Long lived fission product (LLFP) incineration potentials for various nuclear fuel cycles

Neutronic destruction of LLFP requires nuclear systems with a significant neutron surplus. This in turn depends on the overall neutron balance of a given type fuel cycle: neutron losses (neutron leakage, absorption in construction materials [L + CM], etc.), and external neutron sources μ (due to spallation, fusion, μ -catalyzed fusion, etc.). At equilibrium, the neutron surplus G of nucleus J can be expressed through the neutron consumption level, D_J , of J -nucleus as:

$$G_J \text{ neutron/fission} = - D_J - (L+CM)$$

The neutron consumption level D_J depends mostly on: the "family father" J , the neutron spectrum, and neutron flux level (the latter defines competitiveness between "neutron processes and nuclei decay"). Generally for a given fuel loading (nuclei) one has the total neutron surplus G :

$$G = \sum_j X_j G_j + \mu$$

where, X_j is the "enrichment" of the J -nucleus (i.e., the normalized content of J -nucleus) in the fuel loading.

For a just critical system $G=0$, for other cases, the G -value must correspond to the desired multiplication factor of the system. The G -value depends to a great extent on neutron balance enhancement, but there is a reasonable limit since, for all realistic critical reactors, the $(L+CM)$ value is limited to about roughly $0.3n/\text{fission}$. This means that potentially:

$$G = -\sum_j X_j D_j + \mu - 0.3n/\text{fission}$$

From Table 3.8.3 it can be seen that for the thorium cycle, the influence of the neutron flux level is essential to the D and G values (due to ^{233}Pa - burnout effect), while for the main nuclei of the uranium cycle, it is not dominant. The main disadvantage of the thorium-family is the relatively high neutron consumption D and the small neutron surplus available for LLFP-transmutation.

3.8.1.3. Fuel waste toxicity (FWT) source

The fuel waste toxicity time-dependent distribution is shown in Figure 3.8.2 [3.8/4], for the main reactor types with closed uranium and thorium fuel cycles. Standard LWR (open fuel cycle) is reference. The following fuel losses have been taken: 0.3 per cent for uranium, 0.5 per cent for plutonium and curium, and 5 per cent for americium and neptunium.

TABLE 3.8.3. THE D-VALUE POTENTIALS (n/fission) FOR FUEL LOADINGS BY NUCLEI IN THE DIFFERENT NEUTRON SPECTRA WITH "STANDARD" AND ENHANCED AVERAGED NEUTRON FLUXES

J-families	Reactor spectrum type					
	The LWR-spectrum = $10^{14} - 10^{15}$ n/cm ² s		The FR-spectrum = $10^{15} - 10^{16}$ n/cm ² s		The FR-spectrum = $10^{16} - 10^{17}$ n/cm ² s	
^{232}Th	-0.20	+0.08	+0.38	+0.33	+0.02	+1.14
^{233}U	-1.23	-1.24	+1.35	+1.35	+1.28	+1.27
^{235}U	-0.62	-0.65	-0.88	-0.90	-0.88	-0.85
^{238}U	+0.07	-0.01	-0.62	-0.65	-0.04	+0.01

(Data taken from [3.8/2; 3.8/3; 3.8/6])

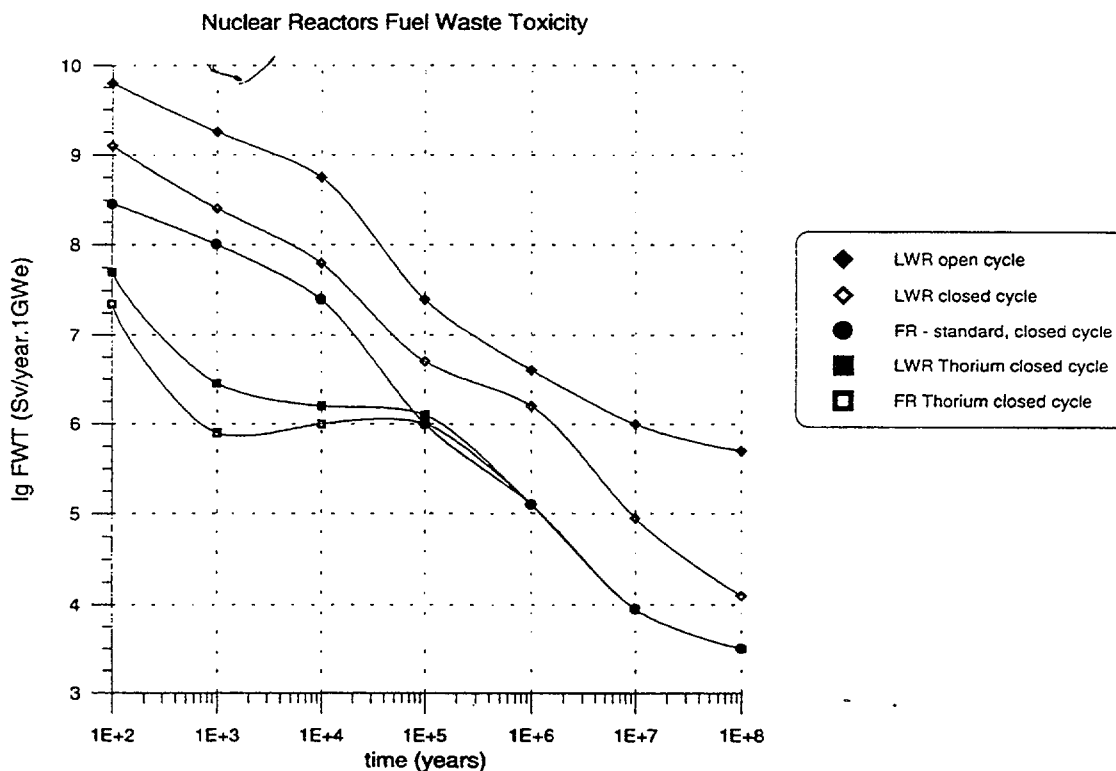

FIG. 3.8.2. Nuclear reactors fuel waste toxicity.

3.8.2. Germany

3.8.2.1. Short term: Mining, fabrication and handling

Th-based fuel has been manufactured for the AVR and THTR, research reactors and PWR test elements, using the proven fuel production technologies for HTRs and LWRs. In view of the higher energy of radiation from natural Th (2 MeV) compared to natural U (0,6 to 0,8 MeV), the exposure of personnel during mining, fuel fabrication, and fuel handling must be more carefully controlled for thorium based fuel. Also, more remote, or shielded, production/handling procedures must be taken. Otherwise no special measures are necessary.

3.8.2.2. Long term: Re-fabrication [3.8/7;3.8/8]

Re-fabrication of ^{233}U -bearing HTR fuel kernels using the sol-gel process has been developed and tested. In conjunction with the chemical process and procedures, equipment for continuous and remotely controlled operation of the fuel fabrication in a hot cell was developed. This was necessary because of the high radiation level of ^{233}U , of the thorium impurities, and other U-isotopes.

Recycling Pu and Th oxide fuel was investigated in a few fuel assemblies in the Lingen BWR in the early seventies. The only available re-fabrication experience with pelletized Th/U-fuel is from the former program in the ITREC-plant in Italy. The hot operation started in 1975 with the reprocessing of 20 Th/U spent fuel elements, irradiated in the Elk River reactor (US). For this first campaign, the most cooled and least irradiated elements were chosen. It was necessary to carry out re-fabrication in a hot cell fitted with adequate shielding, using remotely operated equipment and techniques. Pellets were fabricated from ThU-powder and cutting extracted cylinders obtained green pellets. Sintering was performed in an H_2/Ar -atmosphere between 1600C and 1700C.

After loading the pellets into the Zircaloy-4 cladding, the second end plugs were remotely TIG-welded. The fuel pins were assembled into a Halden type fuel element. In [3.8/9] a procedure is described to limit the toxicity after reprocessing.

3.8.3. India [3.8/10]

Recently there has been much discussion on the differences between the quantity of long lived actinide wastes generated from uranium fuel cycles and those from thorium fuel cycles. Detailed calculations show that the total activity produced in the thorium cycle is lower than that from the uranium cycle after a period of 600 years. The difference between the total long lived radioactive waste material generated in the two fuel cycles has strategic importance in today's political climate. An important factor is the competence with which these materials are handled so the human population is unaffected by the contained radioactivity. For this purpose, it is desirable to have a qualitative idea about the toxicity of the radioactive waste generated.

Like most toxic materials, thorium and its decay products may enter the human body through three different routes: (1) inhalation of thorium and its decay and fission products. Intake by inhalation is possible not only when the nuclide is in gaseous form, but also when these materials are in fine powder form, or are present in aerosols. A portion of the inhaled nuclides can be deposited in the alveoli of the lungs. These inhaled nuclides can then pass through the alveolar wall and be transported through the blood stream and lymphatic system

to organs endowed with abundant reticular endothelial cells. Liver, spleen and bone marrow are possible final depositories for these nuclides. There are other organs with a specific affinity to certain daughter products. For example, ^{224}Ra has a special affinity to the surfaces of the bone.

Another common route for nuclides to enter the human body is (2) by ingestion. Thorium and its daughter products may enter the soil or water, then enter the body through the mucous membranes in the oral cavity or the alimentary canal. So far evidence leads to the conclusion that the absorption of these nuclides through the alimentary canal is extremely small. Only limited data are available on the intake of thorium and its daughter products through the mucous membrane in the oral cavity. It has been reported that investigations on this aspect are being conducted in Japan. It should be noted that ^{226}Ra is absorbed through mucous membranes, both in the oral cavity and alimentary canal. Although there is no evidence to show that ^{224}Ra and ^{228}Ra demonstrate the same tendency; it should be assumed that these two nuclides behave like ^{226}Ra until evidence to the contrary is obtained.

Another route for entry is (3) through absorption by the skin, or directly into open blood vessels. It has been established that this route does not pose serious problems unless the skin is cut and the tissues are damaged. Ingress of thorium through damaged tissue is very harmful. Considerable data are available on this aspect because during the period from 1930 to 1955, "thorotrast", a process using a thorium oxide based material, was extensively used in a few countries for angiographical studies. The Heyden Company of Germany developed the thorotrast process in 1930. Of the 600 patients who survived for more than 20 years, about one in six has developed cancer. Thorotrast-induced malignant hepatic tumors, leukemias, and liver cirrhosis cases have been identified. It must be noted that thorotrast induced diseases required the administration of about 2 g to 20 g of thorium into the blood stream, which is much larger than any natural exposure.

Although it is educational to evaluate the toxicity of materials involved in the fuel cycle, a number of points must be considered. One outstanding aspect is that the toxicity of the materials in the fuel, both before irradiation and after discharge from the reactor, does not in any way indicate the hazard posed by these materials. The toxicity of any material is relevant only when it enters the human body. In that context it is important to realize that there are effective barriers between these toxic materials and the biosphere to ensure that no toxicity will enter the human body. Another fact that needs highlighting is that both natural uranium and thorium ore bodies present in the earth's crust are toxic to a certain extent. The long term toxicity of both types of ore and the radioactive waste generated in fuel cycles is primarily due to radium and its daughter products.

3.8.4. Japan

3.8.4.1. Introduction

Thorium (^{232}Th) is a natural radioactive isotope with a long half-life of 1.41×10^{10} years. The radiation exposure of workers is a serious concern from a health physics viewpoint if unshielded thorium is handled during mining, extraction, fuel fabrication, etc.. In the past, using thorotrast (ThO_2) as a contrast media for medical treatments led to serious problems. Long term low level internal exposure occurs by the inhalation of thorium aerosol. In the thorium decay series, thoron (^{220}Rn) and its decay products are the most important nuclides, in radiation exposure. Since thoron escapes into the air from solids containing thorium, the thoron progeny also exist in the air. Alpha particles emitted from inhaled thoron and thoron

progeny lead to lung and bronchial exposure. This problem is similar to that from radon (^{222}Rn) and its progeny when bare uranium (^{238}U) is handled.

Handling fabricated thorium fuel results in a negligible dispersion of fine particles containing thorium and thoron because the fuel is coated. Thoron would not have enough time to migrate from inside the materials to the air without significant decay.

3.8.4.2. Thoron

Thoron is the only noble gas in the thorium series. A significant quantity of thoron may escape when handling large quantities of thorium. It is characteristic of thoron that the concentration decreases exponentially from the source because of a short half-life of 55 seconds. In Japan, many dwellings are built with traditional soil based plaster with many gaps inside the soil plaster, so thoron diffuses rapidly. As a result, the indoor thoron concentration in Japan is higher than in other countries [3.8/11, 3.8/12]. The thoron concentration has little connection with human radiation exposure because thoron is never deposited in the lungs. However, the thoron progeny, which can be deposited in the lung from inhalation, emit alpha particles and can cause serious radiation exposure.

3.8.4.3. Thoron progeny

Thoron progeny is a series of radioactive nuclides from thoron, primarily ^{216}Po , ^{212}Bi , ^{212}Pb and ^{212}Po . Po-216 is similar to thoron due to a very short half-life of 0.16 seconds. Po-212 is the most important nuclide because it emits high-energy alpha particles of 8.8 MeV.

In general, in a dwelling, the thoron progeny concentration is spatially constant regardless of the position of the thoron source in the room [3.8/13]. Therefore accurate monitoring of thoron progeny does not depend on the position of the measuring instrument.

Thoron progeny monitoring is usually accomplished by collection on a filter using a pump. A semi-conductor detector, a scintillation detector or a solid-state nuclear track detector (SSNTD) is normally used to count alpha particles emitted from the filter. The measurement system with a semi-conductor or by scintillation is precise, but large scale and expensive. With a SSNTD, a portable and low-priced monitor can be applied. A monitor has been developed which can measure the normal level of the indoor thoron progeny concentration by eight-hour continuous sampling [3.8/14]. However there is a problem using this monitor for individuals because carrying a pump and batteries is necessary.

The thoron progeny concentration can be reduced by adequate ventilation. Sufficient ventilation in high thoron concentration rooms minimizes human exposure.

3.8.4.4. Exposure

UNSCEAR gives the conversion factor for the effective dose equivalent per year per unit inhaled concentration, as shown in Table 3.8.4 [3.8/15]. The progeny concentration is expressed by the equilibrium equivalent thoron concentration.

Radon or thoron does not contribute more to the dose than their progeny and the thoron progeny is more important than the radon progeny per unit concentration.

TABLE 3.8.4. CONVERSION FACTOR [$\text{Sva}^{-1}(\text{Bqm}^{-3})^{-1}$]

	Radon or Thoron	Progeny
Radon series	1.5×10^{-6}	9.8×10^{-5}
Thoron series	9.6×10^{-7}	3.7×10^{-4}

3.8.4.5. Conclusions

When bare thorium is handled, the potential radiation exposure of workers to thoron progeny in the decay series is a serious problem. However, sufficient countermeasures can protect personnel against unnecessary radiation exposure by adequate ventilation and individual monitoring control. It should be noted that thoron and its progeny are released into the environment and may cause some exposure to the public.

3.8.5. Russian Federation

3.8.5.1. Comparison of radiation characteristics of initial natural materials for uranium-plutonium and uranium-thorium fuel cycles [3.8/16]

A comparison of the radiation characteristics of ^{232}Th and ^{238}U at different stages of the fuel cycle is presented below. The specific radioactivity of thorium in natural material ^{232}Th , is 4.10^6 Bq per kg of the basic product. The specific activity of uranium, primarily ^{238}U , is $1.3.10^7$ Bq/kg, i.e., the thorium activity is about three times lower than uranium.

Consider the different characteristics of the activity of thorium and uranium as α -, β - and γ -sources. Since the decay chains of thorium and uranium as natural materials are in equilibrium, it can be seen that one decay of ^{232}Th is accompanied by the emission of $E=36.6$ MeV, $E=1.39$ MeV and $E=2.53$ MeV; one decay of ^{238}U is accompanied by the emission of $E=48.65$ MeV, $E=1.96$ MeV and $E=2.05$ MeV.

Since the most penetrating radiation component is a photon, comparison of the energy distribution of photons emitted in the decay chains of ^{232}Th and ^{238}U follows:

- For ^{232}Th , the hardest photon radiation accompanies the β -decay of Tl208, when 1.21 MeV energy is emitted per ^{232}Th decay. This results in forming quanta with 2.615 MeV energy. i.e., the most penetrating radiation.
- In ^{238}U , the most penetrating photon radiation accompanies the ^{214}Bi decay. One ^{238}U decay corresponds to 1.51 MeV energy however, considerable portions of the emitted photons have an energy exceeding 1.5 MeV.

Therefore, the relationship between Th and U as radiation danger sources remains unchanged with regard to differing characteristics.

If only Th is extracted by a radiochemical method during ore processing, then the longest-lived radionuclide left in the waste is ^{228}Ra , with a half-life of $T_{1/2} = 5.75$ years. Thus, there will be no problems with waste disposal. If only uranium is extracted by the radiochemical method, ^{230}Th with a half-life of $T_{1/2} = 7.7.10^4$ years and Ra226 with a half-life of $T_{1/2} = 1.6.10^3$ years remain in the waste. This causes an accumulation of long lived radionuclides in the waste and correspondingly complicates disposal. This problem can be significantly simplified in a complex raw reprocessing with the extraction of not only uranium, but also of thorium and radium.

Further, considering the radiation characteristics of the product extracted from the natural material, in the case of thorium, ^{230}Th and ^{228}Th isotopes are present in the extracted product. During the first several years, the radiation characteristics are determined by the ^{228}Th decay (half-life of $T_{1/2} = 1.91$ years) and after about five years, the decay chain reaches equilibrium. However, for uranium, the radiation characteristics of the products are significantly lower than thorium, since in the period up to 10^5 years they are determined by the first links of the decay chain. Therefore, one ^{238}U decay results in the emission of one order of magnitude less particles and three orders of magnitude less photons. The photon radiation in this case has low energy and handling does not impose serious problems.

It should be emphasized that the recommendations of the International Commission on Radiological Protection on uranium and thorium handling at different stages of manufacture of these materials can be met without much difficulty in any modern plant.

In ^{233}U production by ^{232}Th irradiation in the reactor, several other long lived radionuclides are also produced: ^{231}Pa ($T_{1/2} = 3.276 \cdot 10^4$ years), ^{230}Th ($T_{1/2} = 7.7 \cdot 10^4$ years), ^{234}U ($T_{1/2} = 2.44 \cdot 10^5$ years) and ^{232}U ($T_{1/2} = 72$ years). For large scale ^{233}U production, this can cause the accumulation of considerable quantities of long lived radiochemicals during reprocessing of irradiated material.

In the extracted product, ^{232}U admixtures are the most dangerous although even high concentrations of ^{234}U admixtures do not increase product activity and have no significant influence on radiological conditions at different stages of manufacturing products from ^{233}U . It should be noted that a comparison of ^{233}U with other nuclear fuels, namely ^{239}Pu and ^{235}U , shows that the photon component determines radiological conditions at all stages of manufacture, as well as during preparation of physical experiments. U-233 specific activity is about three times higher than ^{235}U , and is close to that of ^{239}Pu , i.e., ^{233}U radiation characteristics do not differ greatly from traditional types of nuclear fuel.

However, existence of the ^{232}U admixture results in an essential deterioration of the radiation characteristics of the material. The specific unit activity of ^{232}U just after purification from decay products is $2 \cdot 10^3$ times higher than for ^{233}U . Activity components determined by α -, β - and γ -radiation at the initial period, determined by the first links of the decay chains, are characterized by nearly the same ratio. However, considering that the ^{232}U decay chain reaches equilibrium rather quickly, some changes in the proportions of the activity components occur. For instance, for $t=1$ year, the γ -activity of ^{232}U mass unit is $7 \cdot 10^5$ times higher than that of ^{233}U , while the α -activity of ^{232}U is $7 \cdot 10^3$ times higher than that of ^{233}U . Thus, if the ^{232}U content exceeds 1 ppm, then this admixture determines radiological conditions at all stages of the ^{233}U - production chain and during the preparation of physical experiments. It should also be noted that a ^{232}U admixture in the fuel leads to the formation of large amount of thoron (about 10^{12} Bq per 1 g of ^{232}U). This could complicate material handling.

Actual radiological conditions depend strongly on the ^{232}U content in the product yield and on the specific working conditions. Of course, a very high ^{232}U content in the product yield (tens or hundreds of ppm) requires remotely controlled equipment. This shows the necessity of detailed studies on ^{233}U production options and corresponding minimization of the ^{232}U component yield. When ^{239}Pu is used as nuclear fuel, there are also problems concerning admixtures; in particular, the ^{238}U isotope with a half-life of $T_{1/2} = 87.74$ years can strongly influence radiological conditions at various stages of material handling.

3.8.5.2. Environmental impact caused by minor actinides contained in spent fuel for different fuel cycles

Nuclear power generation using the uranium-plutonium fuel cycle results in the accumulation of high toxicity transuranic elements, with correspondingly high environmental impact. The environmental characteristics of nuclear power can be significantly improved by the introduction of fast neutron reactors. Since, for the closed uranium-plutonium fuel cycle this involves the recycling of the radionuclides, including minor actinides, after chemical reprocessing. Thus the quantity of radioactive nuclides requiring a very long period of disposal can be reduced by orders of magnitude.

At the same time, it is clear that such a closed uranium-plutonium fuel cycle can be considered neither the best nor the environmentally safest nuclear fuel cycle, even if super-high values of radionuclide extraction are achieved during chemical fuel reprocessing. The environmentally dangerous plutonium, americium, and curium nuclides would permanently circulate within the fast reactors as nuclear fuel and problems of safe handling and monitoring of these α -active nuclides would still exist.

A more severe radiological problem arises in the closed uranium-plutonium fuel cycle for thermal reactors. In this context, it is important to investigate new fuel cycle concepts, more attractive than the uranium-plutonium fuel cycle from an environmental standpoint. In some publications [3.8/17 to 3.8/21], the specific environmental advantages of the thorium fuel cycle are compared with the uranium-plutonium fuel cycle, namely:

- Important nuclides of this fuel cycle, namely ^{233}U and ^{234}U , are more than one order of magnitude less toxic than uranium-plutonium fuel cycle nuclides ^{239}Pu and ^{240}Pu ;
- The yield of environmentally dangerous minor actinides (neptunium, americium and curium) which create significant problems for the uranium-plutonium fuel cycle is near zero in the thorium cycle.

Fuel irradiation in a reactor to burnup values of 30 GWd/t and 60 GWd/t is shown in Tables 3.8.5 and 3.8.6. Fuel based on the ^{233}U - ^{232}Th cycle gives the minimum yield of minor actinides. For instance, the amounts of neptunium, americium and curium produced are 10^{-2} , 10^{-5} , and 10^{-6} , respectively, less than the corresponding amounts produced in the fuel cycle based on ^{235}U and ^{238}U , with the total amount of minor actinides 10 times lower. The Protactinium isotopes are the most important for the thorium cycle.

It is clear that ^{233}U - ^{232}Th based fuel cycles contain a lower amount of MAs compared to other types of spent fuel after several cycles of irradiation in the reactor (closed fuel cycle). So what is the MA content in ^{233}U - ^{232}Th based fuel after repeated recycling?

Comparison of ^{233}U - ^{232}Th and U-Pu closed fuel cycles for fast reactors is of great interest. Calculated results for asymptotic fuel compositions are in Table 3.8.7. An evaluation has been made for the BN-800 type reactor fuel. The method to determine the equilibrium fuel compositions for the options was compared. The fission products were separated from the spent fuel, with remaining actinides again loaded into the reactor. The required makeup fuel in the core was ^{239}Pu and ^{238}U for the uranium-plutonium cycle and ^{233}U and ^{232}Th for the thorium cycle.

With respect to the uranium and thorium isotopes, equilibrium conditions in the ^{233}U - ^{232}Th fuel cycle are achieved after a few irradiation cycles. Because of the very long period

TABLE 3.8.5. ACTINIDES CONTENT IN PWR FUEL [g/t]; (30 GW d/t FUEL BURNUP, 150 DAYS EXPOSURE AFTER IRRADIATION)

Nuclide	Fuel Type			
	²³⁵ U+ ²³⁸ U	²³⁵ U+ ²³² Th	²³⁵ U+ ²³⁸ U	²³⁵ U+ ²³² Th
²³¹ Pa	1.7E-05	5.6E+01	6.0E-03	5.1E+01
²³⁷ Np	3.6E+02	3.3E+02	7.1E+01	2.4E+00
²³⁸ U	1.2E+02	8.7E+01	4.4E+01	3.7E-01
²³⁹ Pu	5.0E+03	1.0E+01	5.1E+03	3.6E-02
²⁴⁰ Pu	2.2E+03	2.0E+00	2.3E+03	5.9E-03
²⁴¹ Pu	1.3E+03	1.0E+00	1.3E+03	2.3E-03
²⁴² Pu	4.9E+02	1.6E-01	5.3E+02	2.9E-04
Total Pu	9.2E+03	1.0E+02	9.3E+03	4.1E-01
²⁴¹ Am	6.1E+01	3.9E-02	6.1E+0	7.5E-05
²⁴² Am	7.8E-01	2.9E-04	7.6E-01	4.4E-07
²⁴³ Am	9.6E+01	1.8E-02	1.1E+02	2.6E-05
²⁴³ Cm	3.8E-01	5.6E-05	4.1E-01	6.9E-08
²⁴⁴ Cm	2.7E+01	2.8E-03	3.1E+01	3.1E-06
²⁴⁵ Cm	9.9E-01	8.7E-05	1.2E+00	7.9E-08
²⁴⁶ Cm	1.2E-01	5.8E-06	1.5E-01	4.9E-09
<i>Minor actinides, (%)</i>				
Pa	1.7E-05 (0)	5.6E+01 (15)	6.0E-03 (0)	5.1E+01 (96)
Np	3.6E+02 (64)	3.3E+02 (85)	7.1E+01 (25)	2.4E+00 (4)
Am	1.6E+02 (29)	5.7E-02 (0)	1.7E+02 (61)	1.0E-04 (0)
Cm	3.6E+01 (6)	4.8E-03 (0)	4.0E+01 (14)	6.0E-06 (0)
Total	5.6E+02 (100)	3.9E+02 (100)	2.8E+02 (100)	5.6E+01 (100)

TABLE 3.8.6. ACTINIDES CONTENT IN PWR FUEL [g/t] (60 GW d/t FUEL BURNUP, 150 DAYS EXPOSURE AFTER IRRADIATION)

Nuclide	Fuel Type			
	²³⁵ U+ ²³⁸ U	²³⁵ U+ ²³² Th	²³⁵ U+ ²³⁸ U	²³⁵ U+ ²³² Th
²³¹ Pa	2.3E-05	6.1E+01	2.7E-02	6.1E+01
²³⁷ Np	9.0E+02	9.6E+02	1.2E+02	2.7E+01
²³⁸ Pu	4.7E+02	4.4E+02	1.5E+02	7.4E+00
²³⁹ Pu	5.9E+03	7.3E+01	5.9E+03	1.0E+00
²⁴⁰ Pu	2.9E+03	2.5E+01	2.9E+03	2.8E-01
²⁴¹ Pu	1.9E+03	1.2E+01	2.0E+03	1.1E-01
²⁴² Pu	1.2E+02	3.8E+00	1.3E+03	2.6E-02
Total Pu	1.2E+04	5.5E+02	1.2E+04	8.9E+00
²⁴¹ Am	1.2E+02	5.6E-01	1.2E+02	4.5E-03
²⁴² Am	2.0E-00	7.5E-03	1.9E+00	5.1E-05
²⁴³ Am	3.5E+02	7.1E-01	4.3E+02	3.9E-03
²⁴³ Cm	5.2E-01	1.0E-03	5.9E-01	5.1E-05
²⁴⁴ Cm	1.9E+02	2.3E-01	2.5E+02	1.0E-03
²⁴⁵ Cm	1.06E+01	1.1E-02	1.4E+01	4.1E-05
²⁴⁶ Cm	2.1E+00	1.6E-03	3.4E+00	5.4E-00
<i>Minor actinides, (%)</i>				
Pa	2.3E-05 (0)	6.1E+01 (6)	2.7E-02 (0)	6.1E+01 (69)
Np	9.0E+02 (56)	9.6E+02 (94)	1.2E+02 (13)	2.7E+01 (31)
Am	4.7E+02 (29)	1.3E+00 (0)	5.5E+02 (57)	8.5E-03 (0)
Cm	2.2E+02 (14)	3.0E-01 (0)	2.9E+02 (30)	1.4E-03 (0)
²³¹ Pa	1.6E+03 (100)	1.0E+03 (100)	9.6E+02 (100)	8.8E+01 (100)

TABLE 3.8.7. ASYMPTOTIC FUEL COMPOSITIONS IN FUEL UNLOADED FROM BN-800 REACTOR

Nuclide	U-Th fuel cycle		U-Pu fuel cycle	
	Isotope composition of Nuclide,		Isotope composition of Nuclide,	
	g/kg	%	g/kg	%
²²⁸ Th	7.6E-3	-	-	-
²²⁹ Th	1.3E-3	-	-	-
²³⁰ Th	4.8E-3	-	-	-
²³² Th	790	100	-	-
²³¹ Th	0.30	100.0	-	-
Pa	0.30(0.21%)*	100.0	-	-
²³² U	0.31	0.2	1.2E-5	1.6E-6
²³³ U	96.5	70.4	1.9E-5	-
²³⁴ U	27.5	20.0	0.2	0.3E-1
²³⁵ U	6.4	4.7	0.5E-1	0.7E-2
²³⁶ U	6.39	4.7	0.5E-1	0.7E-2
²³⁷ U	2.47E-2	0.1E-1	4.4E-3	-
²³⁸ U	-	-	708.0	99.95
U _{tot}	137.13(97.12%)*	100.0	708.3	100.0
²³⁷ Np	1.53	100.0	0.5	59.03
²³⁸ Np	3.1E-3	-	1.1E-3	-
²³⁹ Np	-	-	0.35	40.97
Np _{tot}	1.53(1.08%)*	100.0	0.85(0.37%)**	100.0
²³⁶ Pu	3.6E-5	-	1.3E-5	-
²³⁸ Pu	1.29	57.9	2.35	1.1
²³⁹ Pu	0.54	24.5	115.0	53.1
²⁴⁰ Pu	0.29	13.2	72.6	33.5
²⁴¹ Pu	4.7E-2	2.2	12.4	5.7
²⁴² Pu	4.9E-2	2.2	14.0	6.5
Pu _{tot}	2.21(1.57%)*	100.0	216.3(96.23%)*	100.0
²⁴¹ Am	1.1E-2	59.4	2.6	53.1
^{242m} Am	7.3E-4	-	0.18	3.7
²⁴³ Am	7.4E-3	40.6	2.12	43.2
Am _{tot}	1.8E-2(0.01%)*	100.0	4.9(2.2%)**	100.0
²⁴² Cm	1.2E-3	14.4	0.32	12.0
²⁴³ Cm	1.7E-4	2.1	5.0E-2	1.9
²⁴⁴ Cm	5.4E-4	65.1	1.75	66.0
²⁴⁵ Cm	9.6E-4	11.4	0.32	12.0
²⁴⁶ Cm	5.9E-4	7.0	0.22	8.1
Cm _{tot}	8.4E-3(0.0%)*	100.0	2.65(1.2%)**	100.0

*) 100% - mass of all nuclides except for thorium

***) 100% - mass of all nuclides except for uranium

required for transuranic nuclides to reach equilibrium (up to one hundred cycles), the evaluation of plutonium, americium and curium effects on the environmental characteristics of the thorium based fuel is only of theoretical interest. Equilibrium of the uranium-plutonium fuel cycle with respect to all nuclides under consideration is achieved much faster than in uranium-thorium fuel. The content of Pu, Am and Cm in thorium fuel will be about 100 times less than in uranium-plutonium fuel.

Table 3.8.8 shows indices of potential danger for asymptotic fuel types. These indices are determined as the relationship of radionuclide activity to its permissible content in the atmosphere or in water. These data show that the thorium fuel cycle is better than the uranium-plutonium fuel cycle. In the near term, the nuclear material indices are near equal for the two fuel cycles. In about 10^3 years, the uranium-thorium fuel toxicity value becomes one order of magnitude lower than uranium-plutonium fuel. Contrarily, within the time range of 10^4 to 10^5 years, uranium-thorium fuel appears to be more toxic because of the accumulation of high toxicity decay products, ^{234}U and ^{233}U . The toxicity indices of uranium-thorium and uranium-plutonium fuels become equal again by the time 10^6 years pass.

3.8.6. USA

Beginning in January 1994, new USA Nuclear Regulatory Commission regulations under 10CFR20 reduced the allowable concentrations of thorium and uranium both occupationally and in air and water effluents. In particular, the ^{232}Th airborne effluent limits are up to 250 times more restrictive than the old limits and the occupational limits are up to 60 times more restrictive. Details are shown in Table 3.8.9. Thorium fuel production has not been undertaken under these new limits, but obviously they pose additional manufacturing problems and hence, significantly increase costs

TABLE 3.8.8. POTENTIAL DANGER INDEX OF 1 KG OF FAST REACTOR FUEL (WITHOUT FISSION PRODUCTS DURING STORAGE TIME)

Fuel cycle	Storage time, [years]					
	1	10	10^2	10^3	10^4	10^5
Thorium	804.0	769	335	12	46	112
Uranium-plutonium	1042.0	770	449	160	54	10

TABLE 3.8.9. COMPARISON OF OLD AND NEW THORIUM AND URANIUM EFFLUENT AND OCCUPATIONAL LIMITS

Nuclide	Airborne effluent limits	Occupational limits	Nuclide	Airborne effluent limits
^{232}Th	1×10^{-12} S	4×10^{-15} W	3×10^{-11} S	5×10^{-13} W
	1×10^{-12} I	6×10^{-15} Y	3×10^{-12} I	1×10^{-12} Y
^{235}U	-----	3×10^{-12} D	-----	6×10^{-10} D
	2×10^{-11} S	1×10^{-12} W	5×10^{-10} S	3×10^{-10} W
^{238}U	4×10^{-12} I	6×10^{-14} Y	1×10^{-10} I	2×10^{-11} Y
	-----	3×10^{-12} D	-----	6×10^{-10} D
	3×10^{-12} S	1×10^{-12} W	7×10^{-11} S	3×10^{-10} W
	5×10^{-12} I	6×10^{-14} Y	3×10^{-11} I	2×10^{-11} Y

S = Material in soluble form; D = half-life < 10 days; Y = Half-life > 100 days; I = Material in insoluble form; W = Half-life 10 to 100 days

REFERENCES

- [3.8/1] PHILIPPEN, P-W., et al., "Gefährdungspotential radioaktiver Abfälle, Auswirkungen der Entwicklung der ICRP-Richtlinien auf die Bewertung", Atw 40 Heft 5 (1995) p. 384-389.
- [3.8/2] SALVATORES, M., SLESSAREV, I., UEMATSU, M., "A global physics approach to transmutation of radioactive nuclei", NSE, 116, 1-18 (1994).

- [3.8/3] BOWMAN, CH., ARTHUR, E., et al., "Nuclear Energy Generation and Waste Transmutation using an Accelerator driven Intense Thermal Neutron Source", LA-UR-91-2601 (1991).
- [3.8/4] SALVATORES, M., SLESSAREV, I., UEMATSU, M., "Physics Characteristics of Nuclear Power Systems with Reduced Long term Radioactivity", NSE (to be published).
- [3.8/5] CARMINATI, F., et al., "An Energy Amplifier for Cleaner and Inexhaustible Nuclear Energy Production Driven by a Particle Beam Accelerator", CERN/AT/93-47 (ET) (1994).
- [3.8/6] TAKAHASHI, H., RIEF H., "Critical review of accelerator-based transmutation systems", OECD-Nuclear Energy Specialists Meeting. Würenlingen 1992.
- [3.8/7] ZIMMER, E., GANGULY, C., "Reprocessing and re-fabrication of Th-based fuel", IAEA-T1-TC-566-III/3.
- [3.8/8] ZIMMER, E., BARNERT, E., NAEFE, P., RINGE, H.D., "Equipment of remote production of coated particles", Proc 28th Conference on Remote Systems Technology (1980).
- [3.8/9] RÜTTEN, H.J., SCHULTEN, R., TEUCHERT, E., "Begrenzung der Toxizität von Aktiniden-Waste", Atw July (1980).
- [3.8/10] JAISWAL, D.D., et al., "Studies on biokinetics and radiation safety aspects of thorium", Proc Indo-Japan Seminar on Thorium Utilization (1990) 281.
- [3.8/11] GUO, Q., LIDA, T., IKEBE, Y., "Thoron and radon concentration measurements indoors with passive cup monitors", Proc. 6th Intern. Conf. Indoor Air Quality and Climate, Helsinki (1993) 517.
- [3.8/12] DOI, M., KOBAYASHI, S., Health Phys., **66** (1994) 274.
- [3.8/13] YAMASAKI, T., GUO, Q., LIDA, T., "Distributions of Thoron Progeny Concentrations in Dwelling", Radiat. Prot. Dosim., (in press).
- [3.8/14] YAMASAKI, T., LIDA, T., "Measurements of Thoron Progeny Concentration Using Potential Alpha-Energy Monitor in Japan", Health Phys., (in press).
- [3.8/15] United Nations Scientific Committee on the Effects of Atomic Radiation, Ionizing Radiation: Sources And Biological Effects, New York (1988).
- [3.8/16] RASKATCH, F.P., SMETANIN, E. Y .A., DUBININ, A.A., CHERNOV, L.A., "Uranium-233, Management in Nuclear Power Industry", report IPPE, No. 8424 (1993).
- [3.8/17] MUROGOV, V.M., TROYANOV, M.F., SHMELEV, A.N., "Thorium Use in Nuclear Reactors", Moscow, Energoatomizdat (1983).
- [3.8/18] MATVEYEV, L.V., ROGOZHNIKIN, V.Yu., "Actinides in liquid wastes, resulted from regeneration of VVER-1000 nuclear fuel", Atomnaya Energiya, V.66, No. 6 (1989), p.388-394.
- [3.8/19] SRINIVASAN, M., et al., "Long lived actinide waste problem, Th-²³³U cycle and fusion breeders", Proc. Intern. Conf. Emerging Nuclear Energy Systems, Madrid (1986)
- [3.8/20] TAKAFUMI, NAKA, TOSHIKAZU, TAKEDA, "Actinide production analysis for Th/²³³U cycle LWR", Proc. Indo-Japan Seminar on Thorium Utilization, Mumbai, India (1990).
- [3.8/21] SRINIVASAN, M., SUBBA, K., DINGANKAR, M.V., "Actinide waste, problem in perspective", *ibid.*

ABBREVIATIONS

ADS	accelerator-driven system
AECL	Atomic Energy of Canada Limited
AGR	advanced gas cooled reactor
AHWR	advanced heavy water reactor
ALI	annual limit on intake
ASMB	accelerator molten-salt breeder (reactor)
AVR	Arbeitsgemeinschaft Versuch-Reaktor
BN	Russian fast reactor
BNAB	Russian library of evaluated nuclear data
BR	breeding ratio
BWR	boiling water reactor
CANDU	Canada deuterium–uranium (reactor)
CERN	European Organization Nuclear research
CESAR	test reactor located in France
CFR	code of Federal Regulations (USA)
CIRUS	Indian research reactor
EBR	extra breeding ratio
EDS	energy dispersive X ray spectroscopy
EFPD	effective full power day
EIR	Eidgenössisches Institut für Reaktorforschung
ENDF/B	evaluated nuclear data file, version b
EU	enriched uranium
FBR	fast breeder reactor
FIFA	fissions per fissionable atoms
FIMA	fissions per initial metal atom
FLATTOP	Los Alamos critical assembly
FOND-2	Russian library of evaluated nuclear data
FR	fast reactor
FSV	Fort St. Vrain HTGR
FWT	fuel waste toxicity
GT-MHR	gas turbine modular high-temperature reactor
HEU	high enriched uranium
HLLW	high level liquid waste
HTR	high temperature reactor
HTGR	high temperature gas cooled reactor
HTLTR	high temperature lattice test reactor
HWR	heavy water reactor
ICRP	International Commission on Radiological Protection
IFMSD	impact fusion molten salt breeder
IGCAR	Indira Gandhi Center for Atomic Research
IHMSB	inertial confined fusion hybrid msb
INFCE	International Nuclear Fuel Cycle Evaluation

IPA	Isopropanol
IPPE	Institute for Physics and Power Engineering
ITREC	Italian test reactor facility
JEF	Joint European Nuclear File
JENDL	Japanese evaluated nuclear data set
JEZEBEL	Los Alamos critical assembly
JMTR	Japan material test reactor
JRR-3M	Japanese test reactor
KAMINI	Indian neutron source reactor
KATHER	critical experiment facility at KFA
KFA Jülich	Kernforschungsanlage, Jülich GmbH (Germany)
KfK	KernForschungszentrum, Karlsruhe GmbH (Germany)
KUCA	Kyoto University Critical Assembly
L	long time interval
LEU	low enriched uranium
LLFP	long lived fission products
LMFBR	liquid metal fast breeder reactor
LMFR	liquid metal fast reactor
LOTUS	Swiss critical facility
LWBR	light water breeder reactor
LWR	light water reactor
MAs	minor actinides
Magnox-Reactors	gas cooled, graphite-moderated reactor with metallic fuel in a Magnox- matrix
MEU	medium enriched uranium
MHR	modular high-temperature reactor
MHTGR	modular high temperature graphite-moderated reactor
MHTR	modular high temperature reactor
MPC	maximum permissible concentration
MONJU	Japanese fast reactor
MSBR	molten salt breeder reactor
MSCR	molten salt convertor reactor
MSR	molten salt reactor
NEC	nuclear energy center
NFC	nuclear fuel cycle
NP	nuclear power
NPP	nuclear power plant
ORNL	Oak Ridge National Laboratory (USA)
OTT	once through thorium cycle
PHWR	pressurized heavy water reactor
PROFIT	plutonium rock like fuel
PWR	pressurized water reactor
PWL	pressurized water loop

RBMK R&D	water cooled, graphite-moderated Thermal power reactor (Russian) research and development
S	short time interval
SGMP	sol-gel microsphere pelletization
SLM	supported liquid membrane
SFPM	synthetic fuel production machine
SSCR	spectral shift controlled reactor
SSET	self sustaining equilibrium thorium fuel cycle
SSNTD	solid state nuclear track detector
SVRC	sodium void reactivity coefficient
SVRE	sodium void reactivity effect
TD	theoretical density
Th-based	thorium based
Thorex	thorium extraction (process)
THORIUM-NES	thorium molten salt nuclear energy synergistics
THTR	thorium high temperature reactor
TPEs	transplutonium elements
TRUs	transuranic (elements)
UNSCEAR	United Nations Scientific Committee on the Effect of Atomic Radiation
WWER	water moderated, water cooled reactor (not VVER)

**NEXT PAGE(S)
left BLANK**

APPENDIX I

PROPERTIES OF THORIUM

Thorium (Table I.I) [I.I] was discovered in Sweden by Jöns Berzelius in 1828 and named after Thor, the mythological Scandinavian god of war. Thorium does not occur to any significant extent in the biosphere and does not normally present a risk to human health. Thorium is a fertile material; there is probably more untapped energy available from thorium in the minerals of the earth's crust than from combined uranium and fossil fuel sources. Thorium abundance in the earth's crust (Figure I.I) is about 6 ppm (uranium, about 2 ppm) [I.I].

Since discovery, the production of thorium has been limited to specific uses (special glass fabrication, gas lightning candles, and special alloys). Production today is several hundred tons per year. There are basically 6 minerals in which thorium occurs at a significant concentration level (See Table I.II).

TABLE I.I. KEY DATA

Symbol	Atomic number	Atomic weight	Group number
Th	90	232.0381	actinide)

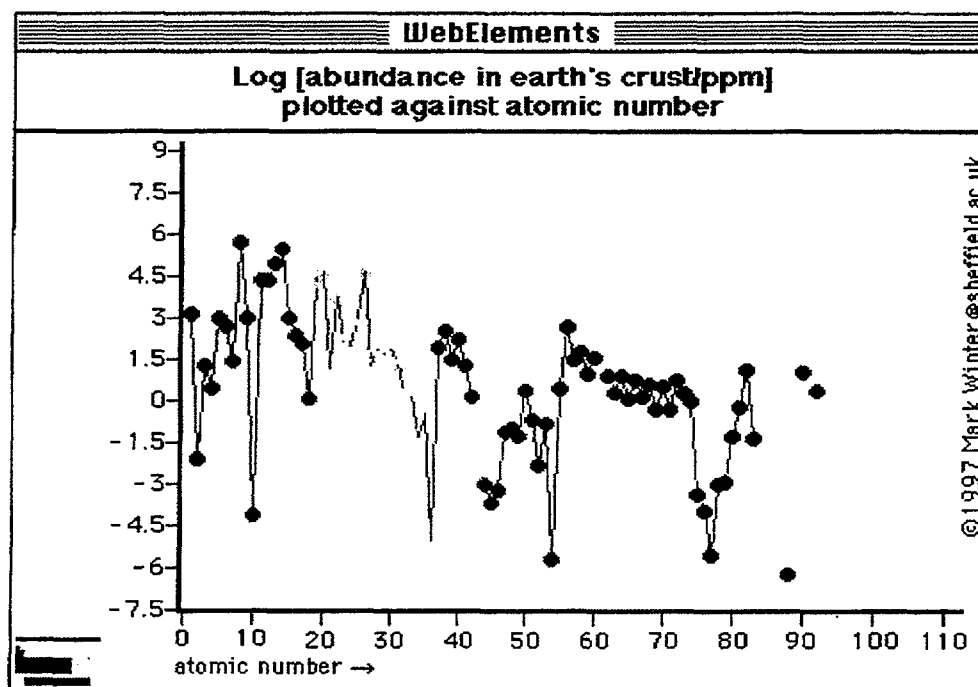

FIG. I. Abundance of elements in earth's crust [I.I].

TABLE I.II. MINERALS CONTAINING THORIUM AS MAJOR CONSTITUENT
[Reference I.II].

Mineral	Composition	Th concentration (% In mass)
Cheralite	(Th, Ca, Ce)(PO ₄ , SiO ₄)	29.5 - 31.5
Huttonite	ThSiO ₄	81.5
Pilbarite	ThO ₂ UO ₃ PbO 2SiO ₂ , 4H ₂ O	31, variable
Thorianite	ThO ₂	38.5 - 93
Thorite	Th (SiO ₄) _x	7.83 - 58.9
Thorogummite	Th (SiO ₄) _{1-x} (OH) _{4x}	24 - 58 and more

Thorium is a radioactive rare earth metal with a half-life of 1.4×10^{10} years (²³²Th alpha decay compared to 4.5×10^9 years for ²³⁸U) and it is a fertile material for nuclear reactors. Thorium fuel cycles require fissile material, which may be ²³⁵U extracted from natural uranium, ²³³U from reprocessing irradiated thorium, or plutonium similarly obtained from irradiated uranium. Up to the present, reactor development has been based mainly on the U/Pu cycle; the Th/U cycle is less developed. During 1950–1970, a number of options for energy production with thorium were investigated in the USA, the USSR, Europe and Asia. Work in thorium cycles focused mainly on the potential for enhancing uranium use in thermal systems.

Additional interest in thorium fuel recently arose because it generates less long lived minor actinides than the traditional uranium fuel cycle. Since the beginning of the 90s, there has been renewed interest in thorium related to accelerator driven systems (ADS). Future hybrid systems such as ADS, fusion driven, etc., using the thorium fuel cycle, have a potential for safe operation, plus the ability to incinerate the most dangerous long lived fission products.

Sufficient information on the physical and chemical properties of the fuel materials is prerequisite to design any type of thorium–fuelled nuclear reactor. Metallic thorium and its alloys, thorium oxide and other ceramics such as thorium carbide and nitride, molten salt with thorium fluoride and others can be considered fuel for thermal and fast reactors. Assessment of these fuel materials depends upon the type of reactors and system of fuel cycles, various physical and chemical properties, mechanical properties, chemical reactions with cladding materials, coolant and fission products, as well as irradiation behaviour.

Properties of thorium metal [I.I]

When pure, thorium is a silvery white air–stable metal and retains its lustre for several months. When contaminated with the oxide, thorium slowly tarnishes in air, becoming gray and finally black. Thorium reacts slowly with water, but does not readily dissolve in most common acids, except hydrochloric. Powdered thorium metal is pyrophoric; heated in air, it ignites and burns with a white light. Thorium metal has a high melting point, a stable isotropic structure below 1360C and good workability. It is soft and ductile with 2 allotropic forms. Some physical properties of thorium metal are shown below:

Density:	11 724 kg m ³ (25C)
Melting point:	2115K
Boiling point:	5093K

Properties of thorium oxide (thoria) [I.III]

Thorium oxide has a melting point of 3300C, the highest of all oxides. Only a few elements, such as tungsten, and a few compounds, such as tantalum carbide, have higher melting points. Thorium oxide is chemically very stable and has low vapor pressures and relatively high thermal conductivities:

Density	10 000 kg m ³ (300K)
Melting point	3370 (C)
Vapor pressure (atm)	3x 10 ⁻⁶ (2600K)

Properties of thorium carbides [I.III]

Next to thoria, the most prominent thorium ceramic compounds for nuclear application are the carbides. In particular, the monocarbide ThC has a relatively high melting point, a high density, a stable isotropic structure up to high temperatures and a high thermal conductivity even though it is highly reactive chemically.

Properties of thorium nitrides [I.III]

Thorium mononitride has a high thermal conductivity and is chemically less reactive to air and water than thorium carbides. However, the adsorption cross section for the thermal neutron of ¹⁴N is relatively large and the nitride is usually unsuitable for thermal reactor fuel.

Molten salt fuel [I.III]

Molten salts such as uranium and thorium fluorides (or chlorides) have useful attributes of chemical stability and good physical properties. The molten salt reactor avoids fuel element fabrication and offers rapid, inexpensive reprocessing, on-line refueling, good neutron economy and high-temperature operation at low pressure.

Nuclear properties of thorium and uranium-233 [I.IV]

Transmutation of ²³²Th into ²³³U is analogous to that of ²³⁸U into plutonium.

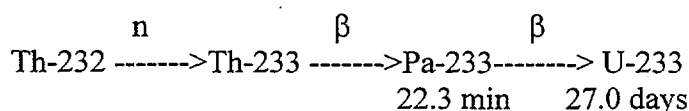
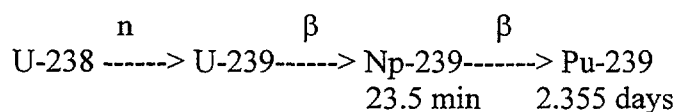

An important feature of the thorium cycle is that a small but significant proportion of the ²³³U undergoes an (n,2n) reaction to form ²³²U, also formed by the sequence:

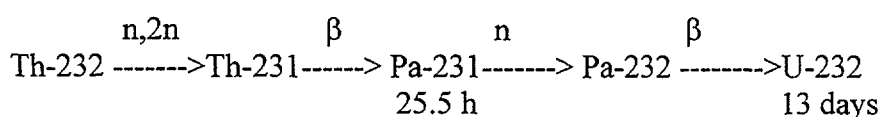

This nuclide decays with a 70-year half-life to ^{228}Th (half-life 1.9 years), then by way of radium-224 and other short-lived intermediates (Figure I.II), with a minor branch to thallium-208 which has an unusually penetrating beta-gamma emission (γ 2.6 MeV). Thorium products require remote handling and a need for heavier shielding than uranium-plutonium fuel during re-fabrication, transport, and storage at the reactor site and thus, complicate reactor facilities.

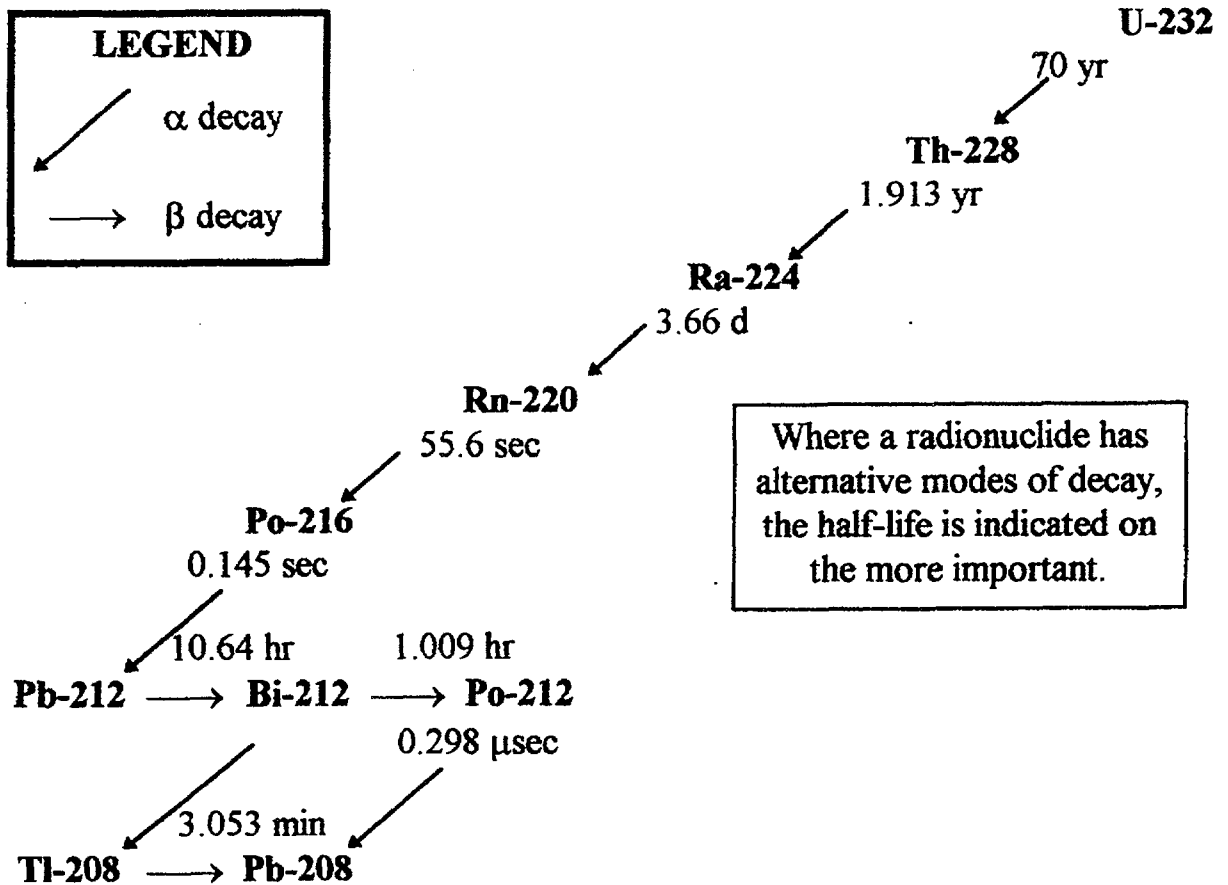

FIG. I.II. Uranium-232 decay series [I.IV].

REFERENCES

- I.I. The Periodic Table on the WWW by Mark Winter, University of Sheffield, UK, (<http://www.shef.ac.uk/chemistry/web-elements/>), 1998.
- I.II. SCHAPIRA, J. P., MENARD, S., "Long term potential risk due to thorium mining", Technical Committee Meeting on Advanced Fuels with Reduced Actinide Generation, Vienna, 1995, IAEA-TECDOC-916 (1996)
- I.III. KANNO, M., "Physical and chemical properties of thorium fuel", Japan -U.S. Seminar on Thorium Fuel Reactors, Nara, Japan, 1982 (1985).
- I.IV. WILSON, P. D., R&T Department, BNFL, Sellafield, UK; AINSWORTH, K. F., BNFL, Risley, Warrington, UK. "Potential advantages and drawbacks of the thorium fuel cycle in relation to current practice: a BNFL view", IAEA Advisory Group Meeting on Thorium Fuel Cycle Perspectives, Vienna, 1997.

CONTRIBUTORS TO DRAFTING AND REVIEW

Drafting

Arkhipov, V.	International Atomic Energy Agency
Balakrishnan, K.	Bhabha Atomic Research Centre, India
Baxter, A.M.	General Atomics Corp., United States of America
Kagramanian, V. S.	Institute of Physics & Power Engineering, Russian Federation
Kimura, I.	Kyoto University, Japan
Meyer, P-J.	Consultant, Germany
Rütten, H. J.	Forschungszentrum Jülich (KFA), Germany
Slessarev, I.	Commissariat Energie Atomique, France
Weisbrodt, I. A.	Consultant, Germany

Review

Akiba, K.	Tohoku University, Japan
Balakrishnan, K.	Bhabha Atomic Research Centre, India
Baxter, A.M.	General Atomics Corp., United States of America
Fukuda, K.	JAERI, Tokai-mura, Japan
Furukawa, K.	Tokai University, Japan
Furuya, H.	Kyushu University, Japan
Ikebe, Y.	Nagoya University, Japan
Ito, Y.	Kyoto University, Japan
Kagramanian, V. S.	Institute of Physics & Power Engineering, Obninsk, Russian Federation
Kimura, I.	Kyoto University, Japan
Kobayashi, K.	Kyoto University, Japan
Muromura, T.	JAERI-Tokai-mura, Japan
Ohsawa, T.	Kinki University, Japan
Rütten, H.J.	Forschungszentrum Jülich (KFA), Germany
Sekimoto, H.	Tokyo Institute of Technology, Japan
Slessarev, I.	Commissariat Energie Atomique, Cadarache, France
Takeda, T.	Osaka University, Japan
Weisbrodt, I.A.	Consultant, Germany
Yamagishi, S.	JAERI, Tokai-mura, Japan
Yamawaki, M.	University of Tokyo, Japan

Consultants Meetings

Vienna, Austria: 29 November – 01 December 1994; 06 June – 09 June 1995
Juelich, Germany: 15 May – 16 May 1997